

# "EASY-BUILD" BR Mk1 MAINLINE STOCK ASSEMBLY INSTRUCTIONS.

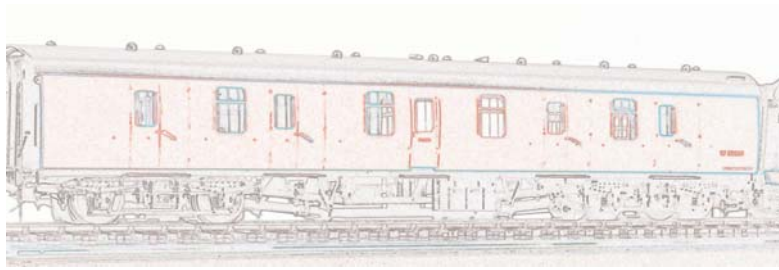

THIS KIT CONTAINS SMALL PARTS THAT MAKE IT UNSUITABLE FOR UNSUPERVISED CHILDREN. SAFETY FIRST! IN ORDER TO CONSTRUCT THIS MODEL YOU WILL BE USING VOLATILE SOLVENTS, ALWAYS FOLLOW THE MANUFACTURERS INSTRUCTIONS AND ENSURE ADEQUATE VENTILATION. YOU WILL ALSO REQUIRE SHARP TOOLS AND THE EDGES OF THE ETCHED PARTS CAN BE VERY SHARP SO TAKE CARE WHEN HANDLING. PLEASE READ THESE INSTRUCTIONS FULLY BEFORE PROCEEDING WITH ASSEMBLY AS MORE THAN ONE ORDER OF CONSTRUCTION MAY BE USED.

## KIT PACKING CHECKLIST

- |                                   |  |
|-----------------------------------|--|
| 1) Floor x1                       | 2) Roof x1                             |
| 3) Sides x2                       | 4) Bogie kit                           |
| 5) Etched Window Frames w/Glazing | 6) Corridor Connections x2             |
| 7) Castings And Details Pack      | 8) End And Underframe Mouldings x2     |
| 9) ABS Angle Extrusions           | 10) 40 thou Micro-Rod (for door stops) |
| 11) Wire (3 sizes)                | 12) Etched Fret Of Components          |
| 13) Styrene Strip (Door Steps)    |  |

## INTRODUCTION

The general idea for assembly is to construct a box with a removable roof, which enables interior details to be fitted exactly where they should be relative to window and door openings. In order to get the most from your kit we recommend you read these instructions in full prior to commencing construction making notes as to any assembly options, or changes to the suggested order you think would suit your method of building better. However, we suggest you do adhere to the order of construction as we know it works! We only recommend solvents suitable for ABS plastics such as Carrs Plastic Weld, or EMA Plastic Weld, Two-part epoxy resins and impact adhesives are suitable for fixing the larger metal parts. To assist you in producing an accurate model, essential dimensions and measurements can be found at the end of the instructions.

1) Let's get started by inspecting the components supplied, there's no point getting involved in construction only to find a damaged part. Start with the large moulded parts (ends, floor, sides, roof and bogie stretchers) checking for severe warping and/or twisting. The floor and roof sections will have a degree of bow along their lengths due to the production process, but you should be able to flatten out the bow without any real effort. Whilst we take great care to weed out sub-standard parts prior to packing, some still slip through occasionally, so remember that any severely mis-shaped parts will be promptly replaced upon return to Easy-Build. Once you're satisfied with the contents, wash all the plastic components with a household detergent to remove oils and contaminants left from the manufacturing process. Now...

## PREPARING THE SIDES

2) Check each side moulding against the edge of the end mouldings. You may also opt to mark each end and side to ensure they can be assembled in the same relative order later. Trim off the ends of the side moulding bottom rib to allow the ends to fit snugly against the sides, approx. 3mm is sufficient. You might also need to flatten slightly any moulded ridges at the top of the sides.

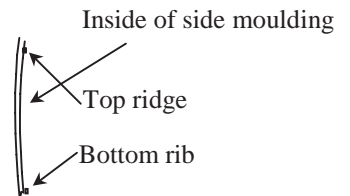

3) If constructing a brake vehicle the guard's doors require the bottoms modifying. They are depicted by removing the bottom of the door level with the bottom of the lip moulded on the inside of the body to the full width of the door opening. Start by cutting (with a fine razor saw) up the door scribe marks, about 1.5mm max., then remove the material between the two cuts (see right).

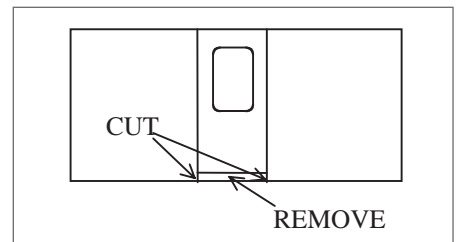

4) With the exception of the guard's compartment, all doors have externally fitted hinges. Having identified guard's compartment doors, where appropriate, drill through all the holes in the sides 0.7mm dia. for door hinges. The guard's doors also have vertical handrails either side of the door, these too need holes drilling through 0.7mm dia. Drill through the bumpstop (those dimples in the centre of the door lower panels and the adjacent dimple at the same height) and door T handle holes at 1mm dia..

5) Check the depth of score lines at the door positions and deepen if you prefer. Carefully remove the raised burr from the door opening score marks with a craft knife, work slowly and re-open score marks as necessary until desired effect has been achieved.

*\*\*TIP - Use a gentle scraping action followed by 600 wet-n-dry (used wet). Alternatively, a small chisel can be used to shave off the burrs. Old flat needle files can be ground into chisels and are ideal for this purpose. Be careful not to dig into the surrounding surface of the sides.*

6) Check the ends of the side mouldings for cutting burrs, removing as necessary ensuring the edge remains square and true. Likewise check all the window openings for burrs - gently scrape the edges as required, but don't be too enthusiastic with the knife!

6.1) Now thoroughly rub down whole side with 600 grit wet-n-dry with plenty of water and rinse with clean water. Repeat steps 5 and 6 until you're satisfied with the smoothness of the side. Make sure you use the abrasive paper evenly over the entire side rather than just the bits you're interested in.

*\*\*TIP - Folding a strip of abrasive paper around a small strip of hardboard works very well*

and ensures the abrasive paper is kept flat onto the surface of the side.

7) Moving on to the door hinges, count how many are required for the type of coach being constructed. You will need 2 tall and 1 short hinge per door remembering that the short hinge goes in the centre with a large hinge top and bottom. Remove an equal number of 'butterflies' from the etch, 1 for each hinge. The hinge piece is pushed through a butterfly shaped backing piece then glued into the hole in the side trapping the butterfly with the hinge. Remember - the guard's doors open inward and so have no visible external hinges.

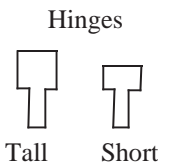

8) Using the 1mm micro rod 'plug' the holes in the door centres and those to the left (and right for baggage doors) of the doors to represent the door bump stops.

The stops should be trimmed so that they protrude not more than 1mm from the sides. Note: doorstops are not fitted to all doors (e.g. guard's doors). You may prefer to leave fitting the door handles and grab irons until after painting, otherwise they too can be fitted now.

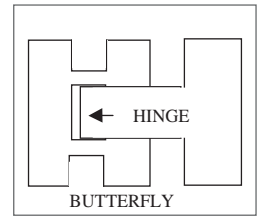

*\*\*TIP - To ensure all the bump stops are trimmed to the same length: drill a 1mm dia. hole in a piece of 1mm (40 thou) thick scrap styrene (or other sheet material). Place the scrap styrene over the micro-rod so that it protrudes through the hole and gently pare back the excess with a sharp knife. Remove the styrene and, once all bump stops have been so treated, give them all a gentle rub over with fine abrasive paper to round the edges slightly.*

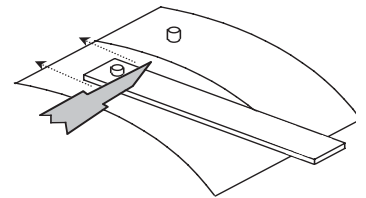

9) if fitting the frameless windows check that they will fit in the openings. Occasionally some openings can be a little too tight for a good fit after the sides have been painted.

*STEPS 10, 11 and 12 refer to the fitting of the later type framed windows, If you are installing the earlier pattern frameless windows, ignore these steps - the frameless windows are fitted after the carriage sides have been painted.*

## **ETCHED WINDOW FRAMES - READ ALL THE STEPS BEFORE PROCEEDING.**

*The window frames do not have an etch number. There are 3 types of frame: large, small and toilet so there shouldn't be too much confusion there. It has been suggested by a customer to leave the fitting of the window frames until the basics of the construction have been completed as the central ventilator bars may get damaged whilst handling. Whilst this is a possibility we have built demo models with the frames in place without a problem, but it is certainly worth considering this option before continuing.*

*\*\*TIP - Before installing the etched window frames check the fit of the window glazing within the openings. Carefully file the edges of the glazing panels until they fit snugly, but not sloppy nor tight.*

10) Carefully cut the window frames from the etch and file the tags smooth taking care not to file into the frame itself. Fit the toilet window vent centrally on its backing prior to frame fitment. DO NOT fold out the central ventilator opening tabs of the main windows until the window frames are fitted.

11) Check that the frames fit the openings (dry run) - the openings should be very slightly larger than the locating lip on the reverse of the window frame.

11.1) (Optional) Curving the window frame slightly can make fitting the frame easier as it will sit against the bodyside rather than springing away (once adhesive has been applied). To do this, place the frame (reverse side down) onto a curved surface such as the top of the roof moulding

(ensuring the curve is in the same plane relative to the window frame as the curve of the side) and gently press it down evenly using a piece of thick card. As you can see from the sides, there's not much curvature required, so be very gentle.

12) Apply a small amount of superglue directly to the rear frame along the edge of the etched lip at the top only. Position the top of the frame into the opening and allow to set. Now, using a small piece of flat material roughly the width of the window frame, gently press the bottom into place and apply glue to the frame/window opening joint from the inside (this is most easily achieved with an old craft knife blade dipped in glue). Once the frame is secure apply more glue to the side joints as appropriate.

*\*\*TIP - Using a slower acting superglue may be preferable when fitting the window frames as it would allow you more time to align the window frame before the glue sets.*

13) Remove any excess glue after glue has set using a glass fibre pen, or fine abrasive paper (glass fibre pen found to be best).

14) Once all is set and clean of excess glue fold the central ventilator tabs outward. First bend the tab slightly outwards before using small pliers both in a squashing action, but don't close the tabs tight together leave a small gap between. You may prefer to leave this until the sides have been assembled, but before painting.

That completes the sides for now.

## ROOF PREP

*You will notice your roof has a curve due to the moulding process this is useful when fitted as it ensures the roof is a tight fit in the centre of your coach.*

15) Clean off any burrs of plastic then put a strip of masking tape down the centre of your roof onto which you can mark the positions of roof vents etc. from the sketches provided (see end of instructions).

16) Remove about 7mm of the inside edge of the roof mounting groove at both ends of the roof - this allows the roof to sit more snugly over the end mouldings. NOTE: **DO NOT** remove any of the (visible) outer edge of the groove as this represents the roof gutter.

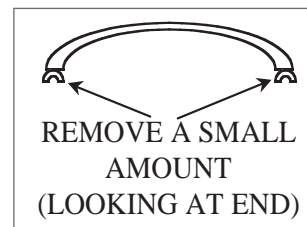

17) Drill the marked vent positions approx. 2.0mm dia. to accept the roof vents and a smaller hole (approx. 1.2mm) for the water fillers then remove tape.

*NOTE, the roof vent positions are scaled from various photographs and so absolute accuracy cannot be guaranteed. If you have more accurate information to hand please tell us and we will update our instructions.*

18) Rub down the whole of the roof down with 600 grit wet-n-dry to smooth out any surface imperfections from the manufacturing process. Don't forget the inside if you're planning to paint the interior.

19) Cut the roof vents from the spues leaving no more than a 2mm spigot with which to attach the vent to the roof. Leaving the spigot longer than 2mm may interfere with the roof fixing clamps later.

20) Fit the roof details - superglue is ideal for this. Before fitting the water filler castings you might consider leaving them removable, i.e. create the water pipes and simply wedge them into the

holes once the roof is in position. This option allows the roof to be removed without the pipes becoming vulnerable as part of a detached roof.

## FLOOR PREP

21) Check the floor moulding for flatness - if it appears too distorted (some curvature is quite normal) bend it in the reverse direction to correct. Check the width of the floor moulding as they can vary as a result of the manufacturing process. The overall width should be approximately 58.5mm. If your floor is significantly wider than this reduce the width by scraping equal amounts off the outer edges of the moulding, however do not make the moulding too narrow, or it will not support the body sides later on.

22) Place the floor moulding top side down on a flat surface to begin detailing - the bottom is that with the moulded ribs on, not the grooves.

*\*\*TIP - Fixing the floor down on to a piece of melamine, or glass with double-sided tape works very well.*

23) Remove the U-shaped and 'T' section mouldings from the sprue, cleaning off any flash as necessary. The 'U' shaped moulding are in fact slightly too tall and should be shortened by approx. 2.5mm at this stage.

24) Using the locating 'dots' on the floor surface, affix 5 of the 'U' mouldings to the floor between the raised centre beams in the order of 1 short, 3 tall, 1 short. Allow joints to fully harden before continuing.

25) Cut 2 lengths of angle truss moulding 209mm (172mm for BGs) and make a notch in one side of the angle 53mm (47mm for BGs) from each end (see diagram right) - a simple cut with a

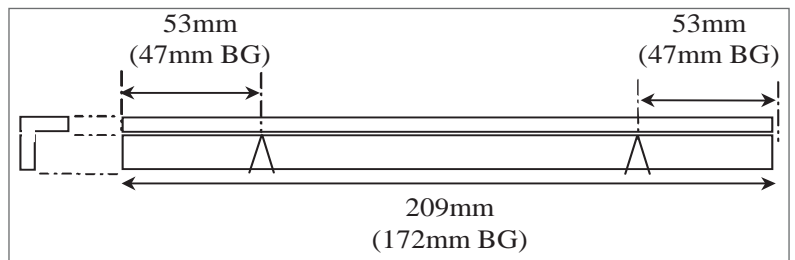

junior hacksaw will create a sufficiently wide notch for our needs. **Check all measurements against your underframe before cutting.**

26) Gently bend the ends of the trusses (closing the notches) to pre-form to shape. Attach the formed trusses to the outside edges of the centre 'U' shaped mouldings with the notches aligned with the centres of the outer tall 'U' mouldings and the ends aligned with the edges of the shorts 'U' mouldings. Allow the solvent to harden on the centre 'U' mouldings before attaching the ends to the short 'U' mouldings as these may need bending a little more to achieve good alignment of the parts. The top of the angle should be level with the tops of the 'U' shaped mouldings.

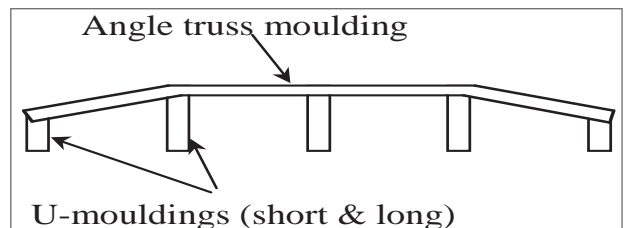

27) With the angle trussing firmly in place affix the T-section mouldings as shown in the diagram (right) between the truss angle and inner face of the solebar. There are long and short T-section mouldings supplied, the short

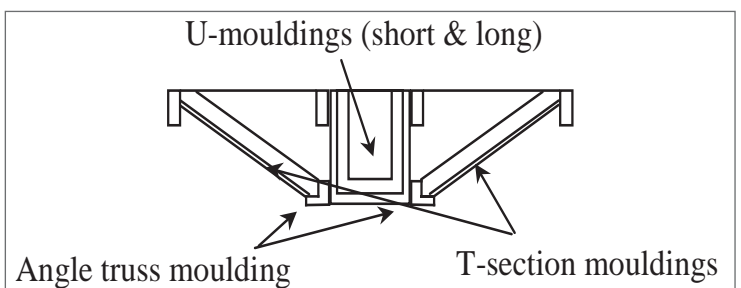

ones are fitted against the short U-shaped mouldings (closest to the bogies), the longer ones being fitted to the centre U-shaped mouldings.

**28)** Locate the two aluminium bogie mounting turnings and prepare them by scoring their upper surface (the upper surface has a spigot that locates in the hole in the floor). Treat the mounting areas likewise. Using a strong adhesive affix the two bogie mountings in their respective holes.

*\*\*TIP - Bogies present quite a load to their mountings mainly due to the ease by which they get knocked and twisted when the model is off the tracks, it is therefore necessary to select an adhesive capable of withstanding such shocks. Two part epoxy resins are more suitable than superglues.*

**29)** To make a much stronger job of fixing the bogie pivots in place, you might consider a 'belt and braces' approach by adding a mechanical fixing to the mounting. Good results have been achieved by drilling two 1mm holes through the bogie mountings and floor (once the mounting has been fixed in place) either side of the bogie pivot bolt, tap 12BA. Now secure the bogie pivot in place by bolting down through the coach floor with short 12 BA bolts.

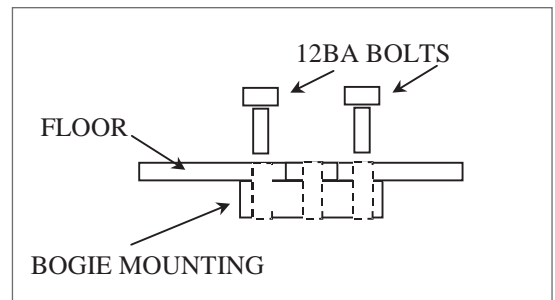

**30)** Clean up all the metal under-floor castings as required. Fold up and assemble the etched brass dynamo mounting brackets and attach dynamo casting. Drill the dynamo mounting lugs 0.7mm and hang the dynamo on the etched mounting arms with brass rod (see photos on our CD).

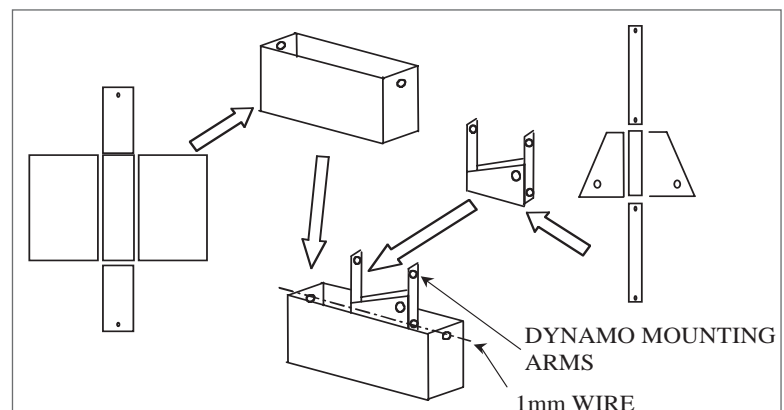

*NOTE: If constructing a BG, take care when placing the underfloor details as they differ in position to the standard underfloor layout. If you intend to fit the lower steps for the guard access doors the regulator bracket will need mounting away from the solebars (the steps hang 15mm below the underside of the floor). See underfloor layout drawing before continuing.*

**31)** Remove the Regulator Carrier Frame from the etch and fold along the half etches to form a U-shaped bracket. Fold in the fuse box mounting plate (away from half etch) and mount the cast metal regulator box and fuse box as shown right (see photos on our CD).

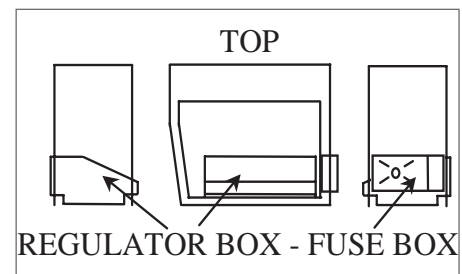

**32)** Remove the brake V hangers from the etch and bend the bottom edge along the half etched line to form a right angle. Check the etched holes in the brake levers for size and open out accordingly. Check and adjust the central holes in the brake pull-rod adjusters also to 1mm dia. - do this before removing the parts from the etch as they're much easier to handle.

**33)** Drill a 1mm dia. hole in the centre of the brake cylinders and glue in a short piece of brass rod (about 20mm protruding out of the cylinder is sufficient). To ensure the brake cylinder sits level

once in position file back the mounting lug on one side only - the central ribs of the floor are taller than the outer (solebar) ribs. Check against the floor until the cylinder will sit squarely. Fit the brake cylinders in place using the underfloor diagram as a plan.

*\*\*TIP - Two part epoxy resins are more suitable than superglues since they are less brittle.*

*Good results have been obtained using impact adhesives such as Evostick (the new Evostick Serious Glue has recently been recommended although we have not tried it ourselves). Whatever type of adhesive you choose remember to roughen-up the surfaces first to improve adhesive grip.*

34) Cut two brake lever pivot bars 39mm long from 1.6mm brass rod and thread the levers and spacers as shown right. The first brake cylinder lever (longer lever) should be about 8mm from the end of the rod and the brake pull rod lever (the shorter lever) about 11mm from the other end, which should be the floor centreline (adjust as required). (see photos on our CD). The two sets of levers should be form a right angle relative to each other as shown far right.

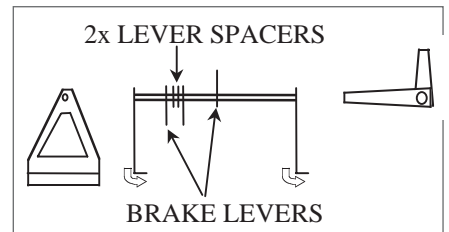

35) Attach to the central brake lever a pull-rod and adjuster that would actually pull the bogie brake gear (see right). The pull-rod length should be trimmed to length just forward of the inner axle of the adjacent bogie.

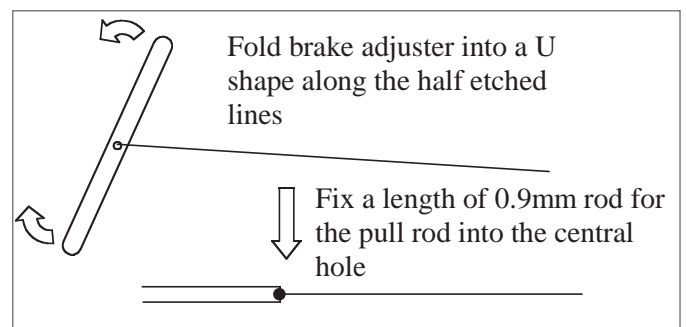

36) Fit the remaining castings in place according the underfloor plan. The brake DA valves mount on the sloping parts of the truss bars. Afix the brass mounting onto the rear of the casting and then onto the truss bars. The etched mounting is angled to ensure the DA valve is vertical once fitted. Position the valves about 10mm from the brake pivot bar (towards the end of the floor). If required, a short length of soft copper wire can be fixed to the top of the valve and into the bottom face of the brake cylinders (see photos on our CD).

## ENDS PREP

37) It is assumed you already know what period and livery you intend for your coach, if not now is the time to make that decision. The reason for needing to make that decision now is because some details are not required for later periods of the BR MK1 stock. As a rough guide the end steps are not (always) required from the later maroon period onwards, i.e. into the blue/grey livery. However, there are examples of some end steps still to be found on certain stock, so checking an example of your particular prototype is strongly recommended. In the absence of specific information, it is recommended not to fit the end steps on stock intended to be painted in the blue/grey livery. Another complication is the fact that there are examples where visual evidence of the positions of the steps remains when the steps themselves have been removed. You can simplify the preparation of the ends by simply leaving the small rectangular pads in place on the end mouldings. Alternatively, flush ends can be modelled by carefully paring off the moulded pads and sanding the areas smooth. Attend to these points now...

38) On one end only remove the moulded details at the top of the ends that represent the emergency brake equipment. Again paring off the thickest parts first followed by gentle filing and sanding smooth. If you are building a BG remove the emergency brake details from both ends.

See above sketch for handrails information on BGs.

39) At the opposite end drill through the outer 'ears' of the emergency brake equipment (0.5mm dia.) and also through the moulded 'block' horizontally. Next drill two 1mm dia. holes - one in the bottom of the aforementioned 'block' and a second in the bufferbeam just to the left of the central section of the end (see diagram).

39.1) Also, if you wish to add electrical cables to the round connection boxes moulded on the end (both ends in fact) drill an appropriately sized hole for the wire being used. Soft copper wire (5amp fuse wire **not supplied**) is ideal to depict this detail and add the End Cable Electrical Plugs etching having first folded it in half which will produce a slot for the wire to fit inside. (see photos on our CD).

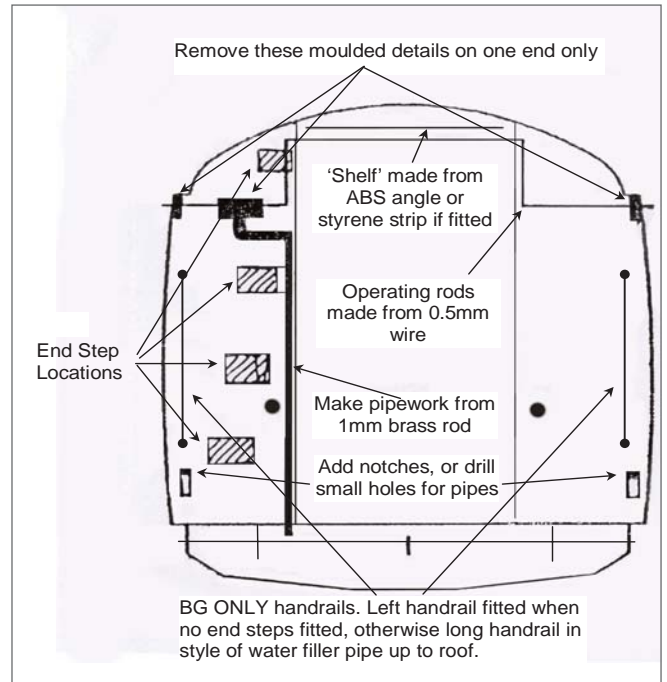

40) Having drilled all the necessary holes make and fit the details from wire as appropriate. Finally, if the end will be fitted with pipes for the water tanks, either drill a small hole in the moulded brackets, or cut a small notch in the inner edge of the brackets to clip the pipe into. If the end doesn't have any pipe work, these brackets can be removed and the area filed smooth.

41) Moving to the bufferbeam fit the end step to the left of the left hand buffer detail and fit the buffer heads into the stocks. If required other details such as vac. pipes (not supplied) can be fitted before the ends are fitted to the floor. Add the Bufferbeam Coupling Reinforcing Plates to the coupling opening and open the slot to accommodate the coupling hook (laminated from two etched parts).

*\*\*TIP - Before fitting the ends to the floor moulding check your chosen prototype to determine which end to fit the emergency brake equipment. One would assume it should be fitted at the same end of each coach, but that appears not to be the case. When checking photographs the brake equipment details can be found both adjacent to, or at the opposite end to the dynamo on the same type of vehicle (?).*

42) With the ends fully prepared they can now be fitted to the floor moulding. Give the inside face of the bufferbeam a quick rub over with a file and present it to the end of the floor moulding. Looking at the (soon to be) inside of the end moulding you will notice a step at the top of the bufferbeam - this is aligned with the top of the floor moulding. Hold the end in place and apply solvent to the joint - be patient the end will have a tendency to simply fall off initially. Once the end has been 'weakly' held in place by the solvent, check the end is stood vertically (from every direction) and is located centrally over the end of the floor. So, Check: 1) the inner 'step' is level with the top of the floor; 2) the end doesn't lean in to, or out of the coach interior; 3) the end is centrally located on the end; 4) the end is stood vertical when viewed end on. That all sounds very complicated, but in fact is quite easy to achieve with a little patience. If the end becomes too stuck to adjust simply apply more solvent to soften the joint. Set the floor aside now for the end joints to fully harden.

*\*\*TIP - Once you are satisfied with the positioning of the ends, it is a good idea to*



*reinforce the underside of the floor/end joint using 1mm (40thou) styrene micro-rod.*

43) Now is a good time to fit the steps to the solebars. Temporarily place a side between the ends and mark the positions of the steps relevant to the doors. The steps themselves are cut from 5mm x 1mm styrene strip. Single passenger-access door steps are 20mm long, baggage doors have 30mm long steps and the combined passenger access/guard compartment door (on brake vehicles) are 40mm long. Attach the steps to the side of the solebar level with the bottom edge. Brass reinforcing pieces are supplied, fold approx. 90° and affix with superglue to the inside of the solebar and bottom of the step. Brake vehicles also have a lower steps at the guard's door, the mountings are supplied on the etch, but consider bogie swing clearances before fitting, especially if you have some tight curves.

## **BUILDING THE BOGIES**

*The steps listed here refer to the standard BR1b bogies as packed in kits. If you have requested Commonwealth, or B4 types please follow the instructions supplied with those bogies as they differ in certain respects.*

44) Remove the bogie frame stretcher plate from the sprue and clean up the edges and square off as necessary.

45) Using a pin, add a tiny drop of oil, NOT WD 40, into each bearing. Push brass bearings into axle holes making sure they are an easy sliding fit, if necessary clean hole with a 2.5mm drill. Do not fix in position as adjustment is made later.

46) Place two axles in the bearings of one side frame and ensuring correct orientation of bogie frame stretcher plate i.e. reinforcing cross members down, assemble the side frame to the frame stretcher.

47) Once the first frame is reasonably firm assemble second side frame onto frame stretcher in the same manner. When the side frames are secure enough to hold themselves in place, make certain all is square and in line, minor adjustments can still be made at this stage by applying more solvent to soften the joints and adjusting as required. Note: wheels should be a loose fit in the bearings at this stage. Leave the bogie to set for at least 1 hour, 2 is better.

48) With the joints set hard we can now set the axle bearings:

49.1) Centralise the wheelset and insert a thin piece of card between each wheel and the side frame to prevent lateral movement.

*\*\*TIP - Do not over-pack the wheelsets as this might cause the sides to spring when you remove the card later resulting in stiff wheel movement.*

49.2) Push in the bearings from the outside until the bearings connect with the axle ends.

49.3) When satisfied that the bearings are (just) against the pinpoint ends fill the bearing hole with the 2.5mm sprue supplied, or microrod (not supplied) and fix with liquid solvent from the outside and leave to harden.

49.4) When set, remove spacing card and trim any excess rod flush with axle box face and fit the axlebox covers in place. Make sure the axlebox covers are fitted centrally and squarely over the axle.

50) Remove the bogie pivot mounting from the casting sprue and remove any flash. Test the bogie pivot bolt is an easy sliding fit in the mounting hole. If tight, open the slightly with a 3.5mm drill 9

(No. 24) to ensure a smooth swivel movement.

**51)** Drop the bogie pivot mounting into its locating holes in the top of the bogie stretcher plate and using only sufficient glue to attach the plates, fit keeper plates over pivot spindles. Ensure pivot remains free to move until the liquid solvent has evaporated.

*\*\*TIP- Some people prefer to use a larger piece of sheet styrene (not supplied) rather than the moulded keeper plates supplied.*

**52)** If desired, fit the brake shoes on the inside of the sideframe. They should be positioned just off the wheels with the circle detail on the shoe just visible below the bottom of the side frame. Mounting pairs of brakeshoes on short lengths of wire makes the fitting much easier, use superglue to affix the wire to the underside of the bogie frame.

If you have followed us so far you will now have a detailed roof, carriage sides, the floor with ends attached and completed bogies. At this point it is recommended that you paint the various parts. Proceed by first giving everything a good wash with water containing a mild detergent and allow to dry thoroughly. Space does not permit a detailed description of how to paint your carriage so it is assumed that you already have that knowledge and skill, or know someone who does. Do not forget to paint the small 'opening' frames on the frameless windows if you are using that type of window. If you are having difficulty in this area please contact us for advice. Remember also to paint the inside of the carriage sides and roof to brighten the interior once assembled, however do not paint below the moulded side ridge and scrape excess paint from the end faces of the sides as solvent will be applied here during final assembly.

*NOTE: Read both steps 52.1, 52.2 and 52.3 before continuing.*

**53.1) Framed Windows** - Install the glazing into the window openings from inside the body, remember to 'frost' the toilet window by rubbing the inside face with 800 grit abrasive paper. Fit dry and secure in place by running dilute canopy glue around the edges with a small brush. Dilute the canopy glue to the consistency of milk and add a single drop of detergent to aid the flow of the glue into crevices.

**53.2) Frameless Windows** - The frameless windows are pressed into the appropriate openings from the inside - some gentle filing of the window may be necessary to get a snug fit - do not make the window a sloppy fit. With the windows in place (dry) adjust their positions to achieve a uniform appearance from the outside of the vehicle. Use dilute Canopy Glue (RC Modelers glue for instance) applied by brush around the edges of the glass from the inside. This adhesive dries clear and quickly and is also flexible - we recommend making at least two applications.

**53.3)** Fit remaining window glazing in door openings.

## **BODY ASSEMBLY CONTINUED...**

OK, you should now have to hand the finished carriage sides, floor, roof and bogies - let's build the body. But first a word of caution: **REMEMBER YOU ARE HANDLING FINISHED COMPONENTS. KEEP SHARP OBJECTS WELL AWAY FROM THE WORK AREA WHEN THEY ARE NOT ACTUALLY BEING USED.**

**54)** First of all check that you have the floor and sides correctly orientated - this is most easily done by aligning the door steps mounted on the solebars with the doors they serve.

Gently roughen the upper surface to the edges of the floor where the side moulding will sit.

*\*\*TIP- Ensure you remove traces of paint from the surfaces to be fixed together as the paint will seriously affect the solvent's ability to create a secure joint.*

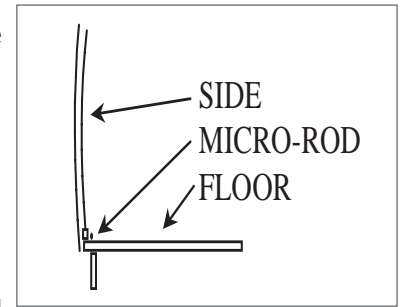

**55)** Working with the side furthest away from you, i.e. you are looking from the inside of the coach, fit the side between the two ends. It is often necessary to bow the side in order to get it in place. Now starting at one end press the side against the floor and also against the moulded end rib and apply solvent between the end and the side. Follow this by applying solvent along the side/floor joint progressively along the length of the whole side and eventually the end rib at the other end. Work steadily and hold the parts together until the bond is sufficiently strong to hold the parts in place. Turn the coach around and repeat for the other side.

*\*\*TIP- Be generous with the solvent along the floor/side joint, less so at this stage at the ends as solvent here can seep more easily onto the painted exterior surfaces.*

**56)** We strongly recommend reinforcing all major construction joints and this includes the side/floor joint and the side/end joints. One of the most effective (and, as it happens, tidy) methods of reinforcing these joints is to use 0.75mm (30thou) micro-rod as a fillet between the two components. Once you are satisfied with the general fit of the sides take a length of micro-rod and place against the side/floor joint in the centre of the coach. Now use copious amounts of solvent to fix the micro-rod in place - pressing it firmly into the joint and working outward from the centre. A similar method can be used at the side/end joint, but with less solvent used here. Set aside overnight to harden. The result is a very strong joint.

**57)** If you intend to detail the interior it would be a good idea to paint the interior floor area now. The fitting of interior components is covered by the supplied instructions.

**58)** Before fitting the roof turn the coach over and fit the couplings.

**59)** Fit the two roof retaining 'nuts' into the roof channel (if not already fitted) and slide to a position directly above that of the 4mm hole in the floor at each end. You will need to give the 'nut' a few strokes with a flat file to make sliding it into the slot easier, however don't make it too sloppy as it can then become very difficult to locate it with the bolt.

**60)** Position the roof in place and secure with the long bolts provided. You may find the sides have bowed inward since you assembled them. If this is the case work initially with one side and locate the top of the side into the groove in the underside of the roof. Once one side is in place gentle pushing and squeezing will be sufficient to encourage the other side into place. Don't apply too much tension with the fixing bolts until the sides are located into the roof grooves as this can impede fitting.

**61)** With the roof in position form from wire and fit the water filler pipes to the ends of the coach. With care a small hole can be drilled into the roof water filler casting and the wires soldered, or glued inside. Since each coach type had different patterns of pipe-work along the roof, follow photographs of your chosen prototype if possible. However, there is a rough sketch and brief description of how the pipes were generally formed included on the page with the roof vent positions to give you a start.

**62)** Fit the door furniture (handles and grab handles, etc.) as appropriate for the types of

doors fitted to your vehicle.

**63)** Fit the bogies in place with the short bolts provided. Adding a smear of glue on the thread of the bolt prior to fitting will be sufficient to prevent the bolt from unscrewing during use - don't apply too much or you may not be able to get the bogies off again - not good!

**64)** Finally, assemble the corridor connections (see appendix) and affix in place ensuring they are fitted vertical and centrally on the end - the bottom of the corridor connection should be level with the top of the corner 'step'.

We hope you have enjoyed building this kit and welcome your comments. These revised instructions have been compiled as the result of listening to our customers experiences. We have attempted to address, or clarify areas of weakness in our suggested procedures and improve the strength and durability of the overall construction methods. We are indebted to everyone who has shared their experiences with us in an effort to improve the experience of building "Easy-Build" products for others - Thank you.

**SHAWN KAY MARCH 2013**

**CONTACT INFORMATION**

## **HMMMM - WHAT A DIFFERENCE!**

**Our guarantee** to you is, by purchasing this kit you should be able to build a high quality model from the components supplied. To ensure this, if you damage a component return it to Easy-Build for a free replacement. If you cannot complete the model we can arrange to complete it for you - we want you to have a completed model to enjoy not a box of half completed bits in a cupboard! If you are unsatisfied with this kit, or the service you have received from Easy-Build in any way, please contact us at our Camelford address without hesitation.

## **"EASY-BUILD"**

Trenarth, Victoria Road, Camelford, Cornwall, PL32 9XE.

Tel: 07834 063966 (before 9pm please)

e-mail: [shawn\\_easybuild@btinternet.com](mailto:shawn_easybuild@btinternet.com)

web: [www.easybuildcoaches.co.uk](http://www.easybuildcoaches.co.uk)

**NOTES:**

**DIMENSIONAL DATA**

Buffer centre height from rail head	3ft 5 <sup>1</sup> / <sub>2</sub> in	24.2mm
Body height (bottom) from rail head:	4ft 1in	28.58mm
Overall body height to apex of roof (not vents, pipes, or periscopes)	12ft 4 <sup>1</sup> / <sub>2</sub> in	86.6mm

**DRAWINGS, ETC.**

**POLY-PACK CONTENTS - AS PACKED**

Door Handles		
Bogie Mountings x2	Roof Fixing Captive Nuts x2	Roof Fixing Bolts (Long Allen Bolts) x2
Roof Tank Fillers x2	Bogie Fixing Bolts (M4) x2	Coupling Hook Springs x2
Regulator Box	Generator	Regulator side box
Roof Vents x20	Fuse Box (Small)	Brake Valves x2
Battery Boxes x2	Buffer Heads x4	Brake Cylinders x2

Water filler pipe-work takes the approximate styles shown here. If the filler is adjacent to the end of the coach the pipes are formed as shown right. Those positioned further away from the carriage end are formed as shown below. Note - these are only to give you a feel for the style - please refer to photographs before making the parts. The shape of the pipes as they run down the end of the body roughly follow the edge of the body end step positions - they were also used as handrails.

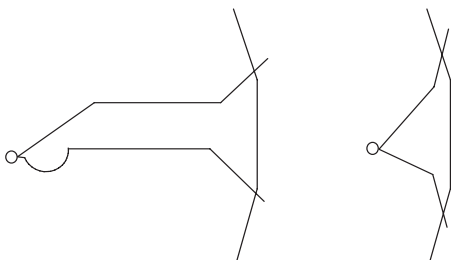

# ETCHED DETAILS IDENTIFICATION

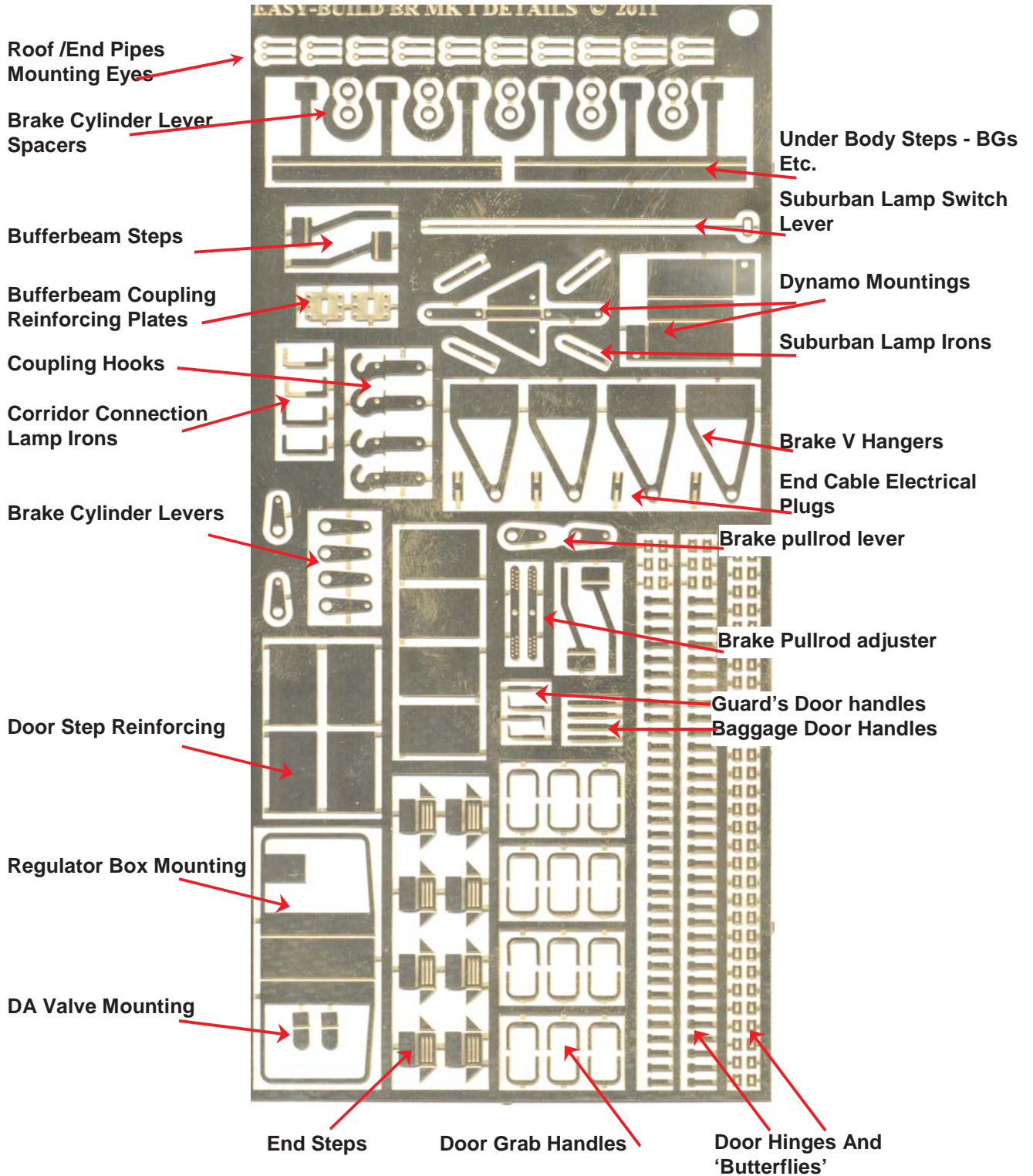

**ARRANGEMENT OF COMPONENTS OF A  
BRAKE END UNDERFRAME  
(NOT TO SCALE)**

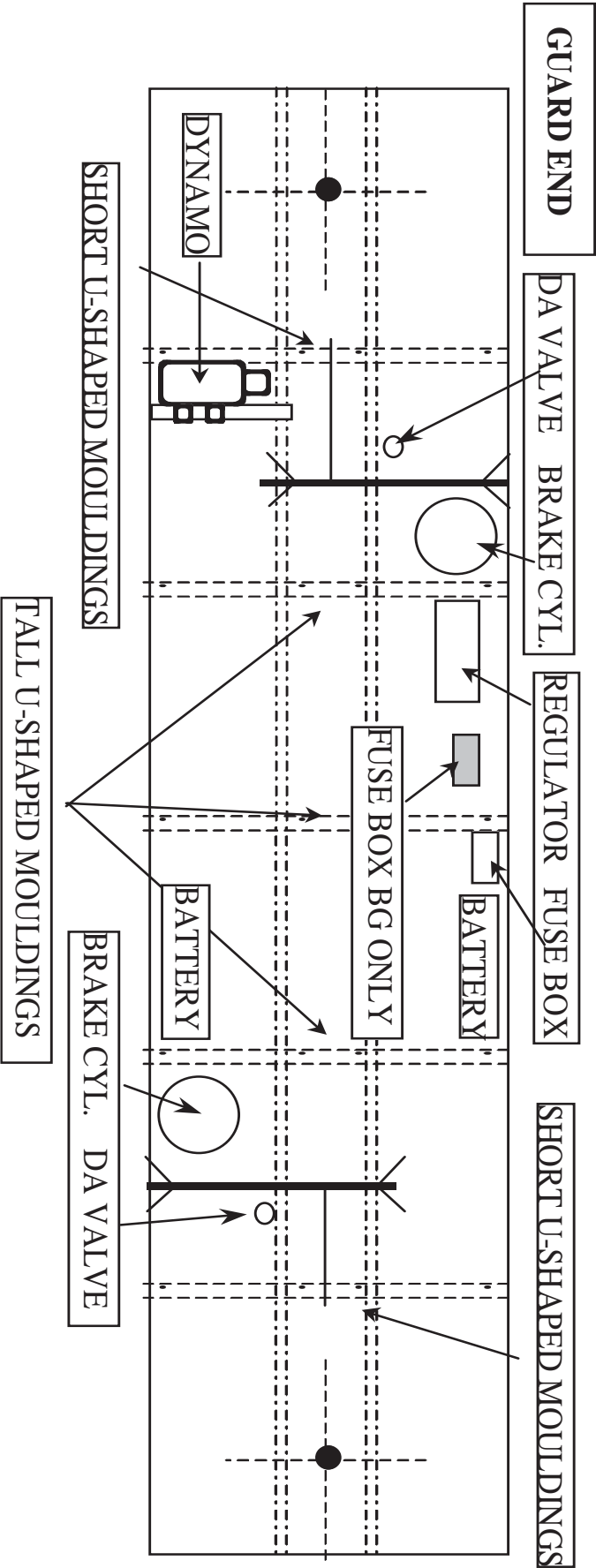

**ARRANGEMENT OF COMPONENTS OF A  
STANDARD COACH UNDERFRAME  
(NOT TO SCALE)**

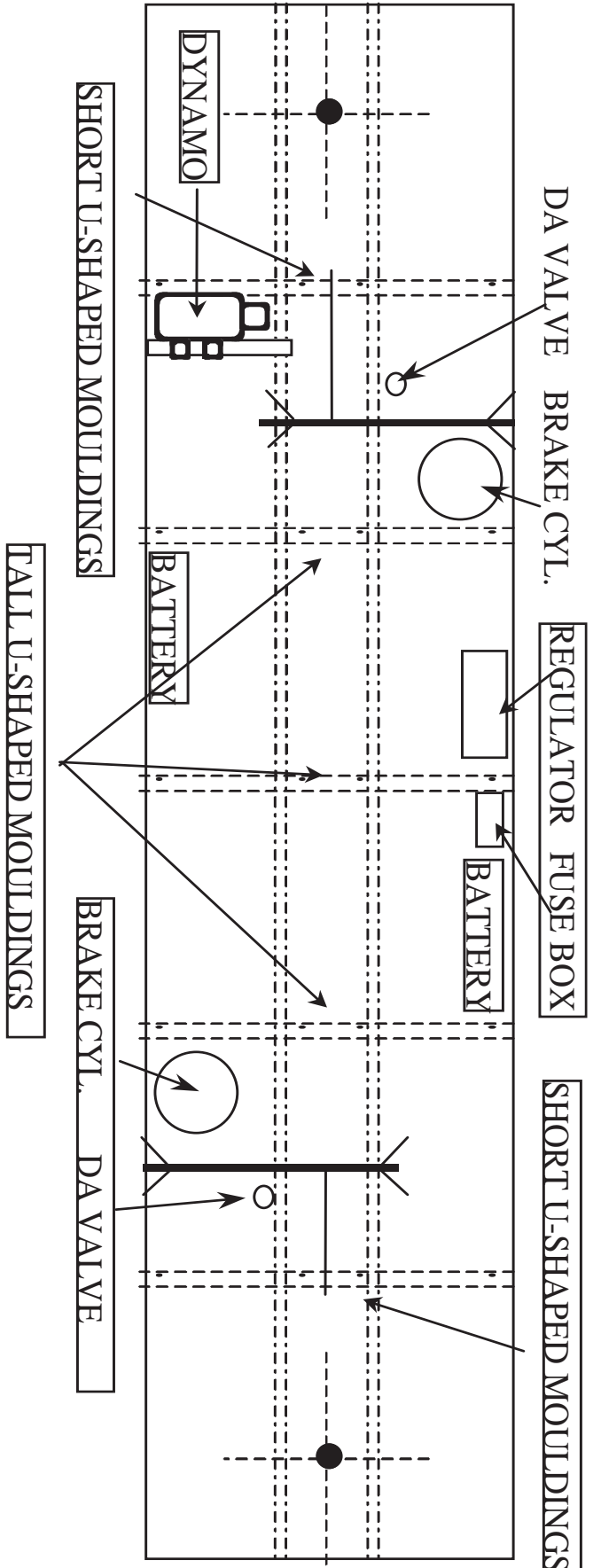

ROOF VENT MEASUREMENTS - BRAKES (in mm)

BSO			BSK		
A	B	W / F	A	B	W / F
43	43	13	43	61.5	11
96.5	96.5	<b>PERIS.</b>	78	114	<b>PERIS.</b>
201	147.5	296	131	146	249
327	254.5	340	167	201	296
360.5	308		219.5	254	
412	360.5		278.5	306.5	
	412		306.5	360	
			360	412	
			412		
BFK			BCK		
A	B	W / F	A	B	W / F
43	61.5	11	60	43	11
96	115	<b>PERIS.</b>	112.5	104.5	324
131	170	278	147	131	<b>PERIS.</b>
238	222	321	201	166	332
310.5	296		253	218	379
363	329		280	271	
435	400		359	342	
			429	394	
BG			BULLION		
A	B	PERIS.	A	B	ARIEL
43	21	160.5	43	61.5	170 - 200
91	73.5	205	79	150	352 - 382
143	126	h/rails	131	308	
197	178.5	16mm long 8mm from ends	308	415	
249	231		405		
301	283.5				
355	336				
	388.5				

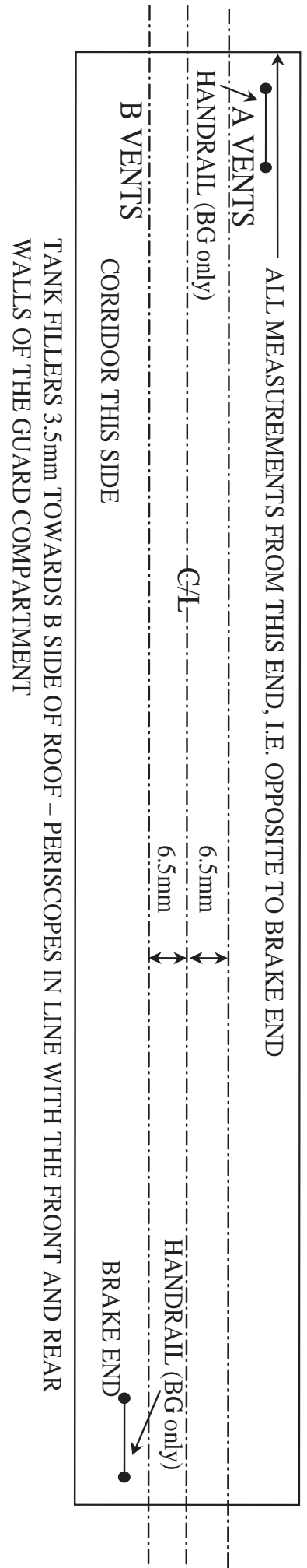



ROOF VENT MEASUREMENTS - NON-BRAKES (in mm)

FK			SK		
A	B	W/F	A	B	W/F
43	78	13	42	42	411
59	131	442	77	93	
111	183		130	145	
166	237		164	180	
218	305		233	249	
289	357		268	302	
324	393.5		321	335	
377			355	372	
413			426	426	
CK			SO (DIA 89)		
A	B	W/F	A	B	W/F
60	37.5	13	42	58	412
95	77.5	442	77	93	
148	130		130	145	
218.5	166		164	180	
271	236		233	249	
324	289.5		268	302	
378	343		321	335	
	395		355	372	
	413		426	426	
SO (DIA 90)			FO		
A	B	W/F	A	B	W/F
43	78	412	43	43	13
78	182		79	79	442
130	342		131	183.5	
252	375		254	323	
375	426		377.5	377.5	
426			413	413	

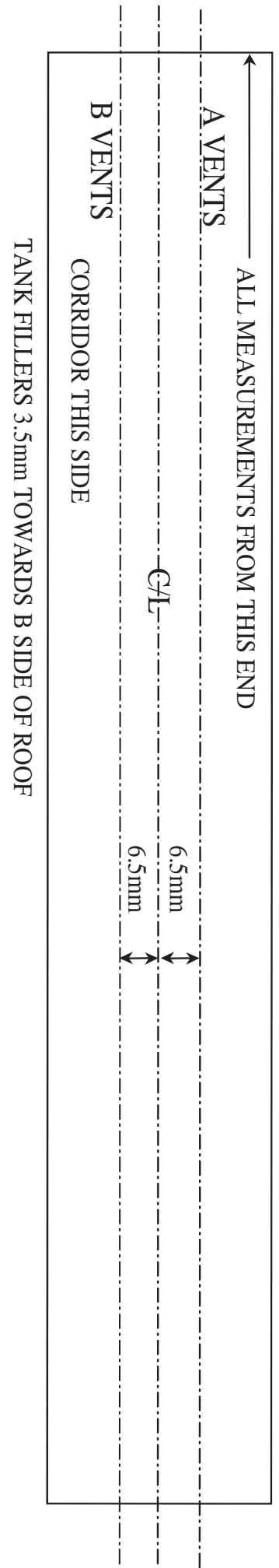

## APPENDIX

### Corridor Connection Assembly.

The basic components are illustrated here (right). Note that the bellows have a front and rear, with the square section being the rear. The mounting plate should be painted to match the colour of the end of the carriage, this is best done before assembly.

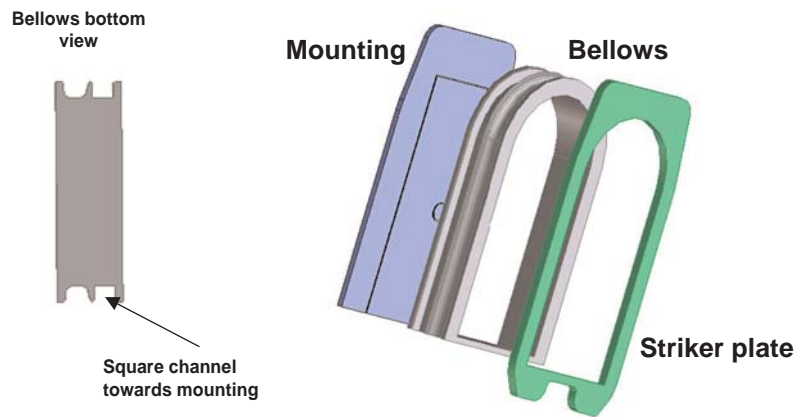

- 1) Remove the mounting and striker plates from the sprue and smooth off the feeds.
- 2) Inspect the edges of the bellows for signs of flash, which gives the edge a crinkly appearance. To remove the flash, carefully clip the thin crinkles back to the smooth edge, this is best done with scissors, or end clippers. Finish off the trimming with 400 grit abrasive paper as required. Also, give the the ends a rub over to improve adhesion.

3) The floor across the bottom of the bellows can be removed to increase flexibility when used within a train, or left in place for an end coach.

3.1) To remove the floor section, cut vertically downwards on the inside of the bellows opening with a sharp blade. DO NOT reduce the bellows height.

4) Starting at with bottom corner of the striker plate, secure the bellows with a spot of superglue. The bottom of the bellows align with the top of the opening in the striker plate.

5) Keeping the edge of the bellows aligned with the edge of the striker plate, continue gluing up the side to the point where the arch begins. STOP.

6) Repeat steps 4 and 5 on the other side.

7) The bellows around the arched opening can now be fixed ensuring they follow the outline of the curve.

8) Now repeat steps 4 to 7 to afix the mounting plate noting the bottom of the mounting is level with the bottom of the bellows. Ensure the door outline faces into the bellows before you start gluing!

9) Give the edges a gentle rubbing over with fine abrasive paper to remove any excess glue.

