

"EASY-BUILD" GLOUCESTER RC&W / PRESSED STEEL Co. CLASS 121 / 122 ASSEMBLY INSTRUCTIONS.

PLEASE READ THESE INSTRUCTIONS FULLY BEFORE PROCEEDING WITH ASSEMBLY. SAFETY FIRST! IN ORDER TO CONSTRUCT THIS MODEL YOU WILL BE USING VOLATILE SOLVENTS, ALWAYS FOLLOW THE MANUFACTURERS INSTRUCTIONS AND ENSURE ADEQUATE VENTILATION. YOU WILL ALSO REQUIRE SHARP TOOLS AND THE EDGES OF THE ETCHED PARTS CAN BE VERY SHARP SO TAKE CARE WHEN USING AND HANDLING THESE ITEMS. WORK STEADILY AND SAFELY AT ALL TIMES.

CONTENTS

2x moulded body sides (left and right),	1x moulded roof section,	1x moulded floor section,
2x moulded cabs,	1x non-powered bogie,	1x casting pack,
1x bufferbeam pack,	1x glazing pack,	1x moulded seating pack,
1x sheet styrene,	1x clear styrene,	1x fixing pack & couplings,
1x Etched brass sheet of details (large)	2x Etched brass sheet of details (small)	
2x ABS moulded body stretchers	misc. styrene strip, silicon tubing and wire.	
1x Power bogie pack containing:		
2x Pickups w/wire, 2x sideframes and bolster details, 4x axle bearings, 1x motor, 1x worm gear, 1 x bogie pivot 'top-hat', 4x 2mm nuts, 4x 2mm bolts, 1x delrin chain (approx. 6"), 2x drive wheel sets, 1x bogie stretcher plate, 1x LH sideframe mountings, 1x RH sideframe mounting.		

INTRODUCTION

Whilst no special skills are required to construct this kit, please remember it is not a 'shake the box and out comes a completed model' kit! Some parts will require fettling as with any kit and taking your time with those tasks will be reflected in the final results. In order to get the most from your kit, we recommend you read these instructions in full prior to commencing construction making notes as to any assembly options, or changes to the suggested order you think would suit your method of building better. The prototype photographs on the photo-reference CD-ROM depict a preserved unit, however they do show the main (externally visible) underframe details clearly, though some items of equipment have been fitted to meet new safety standards and, as such, are not appropriate for 'period' scenes. For final detailing, working with both the drawings and the photos will produce a very accurate representation of the underframe components. You will see various references to photographs throughout these instructions, which are all to be found on the CD-ROM in the 'Class 121 And 122' folder and 'Class 121 And 122 Prototype' folder. Note that there may be photographs of other DMUs on the disc which may show details that are applicable to this model also, so scanning through the whole disc may be useful.

PREPARING THE SIDES

1) Let's get started by inspecting the components supplied, there's no point getting involved in construction only to find a damaged part. Start with the large moulded parts (ends, floor, sides, roof and bogie stretchers) checking for severe warping and/or twisting. The floor and roof sections will have a degree of bow along their lengths due to the production process, but you should be able to flatten out the bow without any real effort. Whilst we take great care to weed out sub-standard parts prior to packing, some still slip through occasionally, so remember that any severely mis-shaped parts will be promptly replaced upon return to Easy-Build. Once you're satisfied with the contents, wash all the plastic components with a household detergent to remove oils and contaminants left from the manufacturing process. Now...

2) Check the depth of score lines at all door positions and deepen if you prefer. Carefully remove raised burr from door opening scores, work slowly and re-open score marks as necessary until desired effect has been achieved. Also score the bottom of the guard's door 2.0mm up from the bottom of the side.

DOUBLE 'BAGGAGE' DOORS

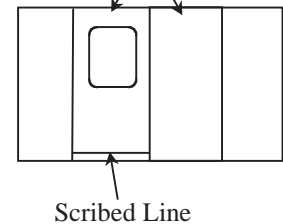

***TIP - Use a gentle scraping action followed by rubbing over with abrasive paper such as 800 grit wet-n-dry (wet is best) for these two operations. Alternatively, a small chisel can be used to shave off the burrs (old flat needle files can be ground into chisels and are ideal for this purpose), again followed by the abrasive paper.*

3) Drill through all the pre-marked holes in the sides as follows:

0.7mm - Door hinges (there are no pre-marked drilling points for the guard's doors hinges as they would open inward). Guard's doors vertical handrails either side of the door.

1.0mm - Door bump-stops (these are the holes in the middle of the door panels with a corresponding hole to the left, or right of the door).

0.5mm - Guard's doors handles, baggage doors handles, passenger door grab handles and cab handrails.

1.2mm - All other door handles (T-handles).

4) From 0.7mm wire, form the 8 handrails for the guard's compartment doors (4x long and 4x short) to fit the holes drilled.

5) Check the fit of the sides against the cab ends. The sides should be positioned level with the bottom edge of the cab. The upper corner of the end, where the roof meets the edge of the door opening has a small radius and taper (a production process aid) and will also need to be filed square in order to accurately align the sides. Don't forget both ends have to fit both sides!

***TIP- Number the ends and sides on the inner surfaces to ensure each side mates with it's appropriate end later on.*

6) Now would be a good time to give the whole side a rub down with abrasive paper such as 800 grit wet & dry. At this stage you can go over any of the previous body preparation operations quite easily until you are fully satisfied with the results. Once the door hinges, etc. are in place it is much more difficult to do so. Also, if you intend to paint the interior of the vehicle, don't forget to give the inside face of the sides a rub down too. Failing to do this could result in poor adhesion of the interior paint and it is very difficult to rectify that problem when everything else is done.

7) You will now require 48 etched door hinge assemblies (32 long and 16 short). Before getting too involved check (or at least decide one way or the other) whether your chosen prototype had doors with self-aligning hinges, which can be identified by the 'butterfly' style hinge mounting. The T-hinge is pushed through a butterfly shaped backing piece then glued into the hole in the side trapping the butterfly with the hinge. If these butterflies are not apparent then simply push the T-shaped hinge through the previously drilled holes in the body sides. The short hinges are for the centre hinge locations with a long hinge top and bottom. Remember - the guard's doors open inward and so have no visible external hinges. You will require another six hinge assemblies eventually for the cab doors, but not until later.

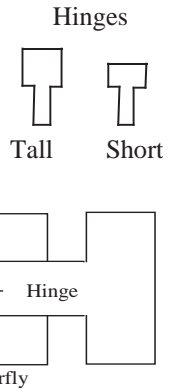

8) Using the 1mm micro rod 'plug' the holes in the doors centres and those to the left and right of the doors to represent the door stops. The stops should be trimmed so that they protrude not more than 1mm from the sides. Note door stops are not fitted to all doors.

***TIP - To ensure all the bump stops are trimmed to the same length: drill a 1mm dia. hole in a piece of 1mm (40 thou) thick scrap styrene (or other sheet material). Place the scrap styrene over the bump stop so that it protrudes through the hole and gently pare back the excess with a sharp knife, followed by a fine file. Remove the styrene and, once all bump stops have been so treated, give them all a gentle rub over with fine abrasive paper to round the edges slightly.*

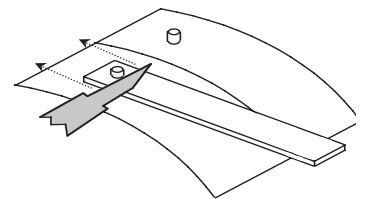

DO NOT ASSEMBLE THE SIDES AND ENDS AT THIS STAGE.

ROOF PREP

You will notice your roof has a curve due to the moulding process this is useful when fitted as it ensures the roof is a tight fit in the centre of your coach.

9) Clean off any burrs of plastic then put a strip of masking tape down the centre of your roof onto which you can mark the positions of roof vents etc. from the sketch provided.

10) Drill your marked positions 2.8mm dia. to accept the roof vents and remove tape (see ROOF VENTS diagram on page 18). Clean off any burrs around the holes. Do not fit the vents yet.

11) If you intend to paint the interior, rub down the underside of the roof (the interior surface) with abrasive paper to improve paint adhesion.

FLOOR PREP

12) Clean off burrs due to the machining processes.

13) Remove the partly cut out motor mount area and clean up the edges of the cut as necessary.

14) Locate the two aluminium bogie mounting turnings and prepare them by scoring their upper (flat) surface (the spigot hangs down in order to provide the correct body ride height). Treat the mounting areas likewise.

15) Using a strong adhesive fix the two round turned bogie mounts in the circles provided and ensuring the mountings sit fully flat to the surface of the floor.

NOTE: See Modification To Floor on page 16 for details of a small modification necessary to allow the motor bogie to have full movement.

16) (OPTIONAL) You may prefer to strengthen the assembly by adding two bolts to the

assembly, we use 12BAs (see right). This is best achieved after the boss has been glued in place. Drill holes 1.1mm dia. and tap 12BA through both the floor and boss. Add bolts and file off any thread protruding from the underside of the boss. However, you may prefer not to insert the bolts just yet as they will prevent the floor from laying flat when upside down, which is useful when adding the underframe details. This could also be done using small self tapping screws.

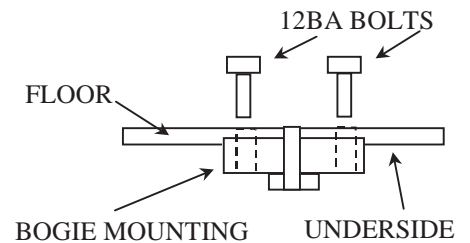

ENDS PREP (SEE NOTES(P14) FOR USING ETCHED WINDOW FRAMES E30)

17) Ensure the corners under the roof at the door top positions have been filed as noted previously and remove any moulding flash from window openings, etc..

18) Drill two 0.4mm dia. holes in the centre of each of the outer windows directly above the upper window beading to mount the windscreen wipers later.

18a) You will also need to drill holes in one end to mount the exhaust stacks, however these are better left until you've made the stacks to ensure correct alignment. The mounting rings should be placed just below the gutter rail.

19) Cut glazing to fit the windscreens. Start with 6 pieces 15.5mm x 24.5mm and then round the corners sufficiently to clear the moulded inside corners of the glazing recess inside the cab. Do this now as it is very difficult to do ensure a good fit once the body has been assembled. DO NOT FIT just keep the glazing safe for now.

NOTE: If you intend to illuminate the end lights these should now be drilled out as required. No provision is made for this in the kit and so it is up to the builder to determine how best to achieve the installation.

20) Cut from scrap styrene 4 desk mountings 10mm x 13mm and fix (2 each end) on the floor about 8mm in from the side of the cab and against the cab front - photo: Craven inside cab.jpeg for example

21) Various parts are supplied to depict the various destination and headcode panels that adorned the front of these units over the years.

22.1) For the early 2-digit front mounted headcode use part E15. This is intended as a frame to place over a headcode 'behind glass' so could be left off until finishing. Or, fit now and fill the openings with glass later - your choice. With this option the small roof mounted destination board should be fitted. This is a casting (C28) and should be mounted centrally above the gutter.

22.2) For the 4-digit headcode box that fits above the gutter use part E11. To use this, fold up using the half-etched lines as guides (to the inside). Ensure the folds produce neat square edges and use solder, or adhesive to secure shape. If you wish to illuminate the headcode fix a piece of clear styrene (not supplied) behind the opening using E29 as a guide for size. Otherwise fix E29 inside the opening.

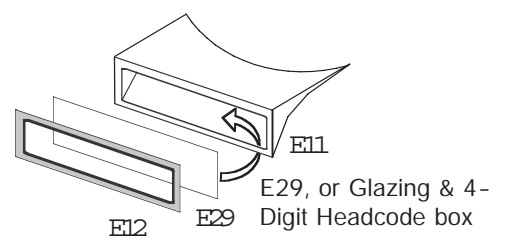

The completed box sits about 1.5 - 2mm up from the gutter on the front of the cab with the front face vertical. Some minor trimming of the edges of the folded box might be required to achieve the best fit possible. You might also need to file the front of the cab roof a little flatter to allow the bottom of the headcode box to sit neatly against the cab

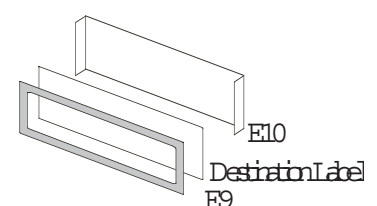

roof (the cab front bows outward slightly). Part E12 is the front of the headcode box and should be fitted with a glazing panel in front of E29 once the unit is finished. With this option, the destination board moves inside at the top of the cab centre window. Fold part E10 along the half etched lines and paint. A destination label is then glued between the folded ends and then the front E9 placed on top of that. The whole thing is then attached behind the centre cab window after painting the unit.

DO NOT FIT YET.

BODY ASSEMBLY

Whilst the solvents used to assemble the components evaporate very quickly the joints they produce take considerably longer to achieve maximum strength. DO NOT RUSH THESE NEXT STEPS. Leaving ample time for the joints to harden is essential and you will be rewarded for your patience by not having unsound joints later on.

23) Fix a cab end to the opposite ends of each side to each end to form an 'L' shape half box as shown right. Assuming care was taken when preparing the ends and sides (including identifying which end and sides adjoin each other) your sides will be level at the bottom. Ensure the outside faces of the sides are a good match, in profile, to the outside of the ends at the door line.

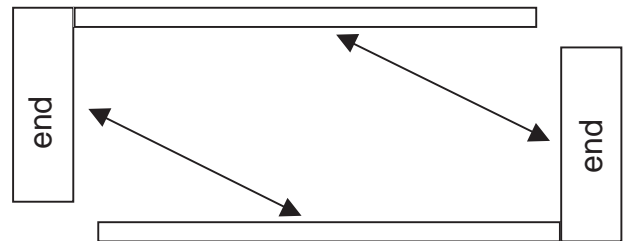

***TIP - Working on a glass sheet will aid accurate bottom alignment of the sides and ends.*

24) Assemble the two half boxes again using a flat surface to aid alignment. Use the roof to check the alignment of the ends. The box may twist a little to during this process due to the flexible nature of the materials, but do not worry unduly as the roof will bring everything back in line later. Be very careful when handling the 'box' as at this stage it is a bit floppy and can easily be damaged.

LEAVE TO SET HARD AND BUILD THE BOGIES

The instructions here initially refer to an un-powered bogie. Note also that the bogie spues contain parts that are not intended for the DMU so please refer to the illustrations to identify the appropriate parts to use.

25.1) Remove the bogie frame stretcher plates from the casting sprues and cut off the ends level with the inside edge of the moulded angle (see right). Clean up and square off as necessary.

25.2) Push brass bearings into the axle holes making sure they are an easy sliding fit, but not sloppy - if necessary clean hole with a 2.5mm drill. Do not fix in position as adjustments will be made later.

25.3) Using a pin, add a tiny drop of oil (NOT WD 40) into the bearing surface.

25.4) Place two non-driving axles in the bearings of one side frame and, ensuring correct orientation of bogie frame stretcher plate (reinforcing cross members down), assemble the side frame to the frame stretcher.

25.5) Once the first frame is reasonably firm, assemble second side frame onto frame stretcher in the same manner. When the side frames are secure enough to hold themselves in place, make certain all is square and in line, minor adjustments can still be made at this stage by applying more solvent to soften the joints and adjusting as required. Note: wheels should be a loose fit in the bearings at

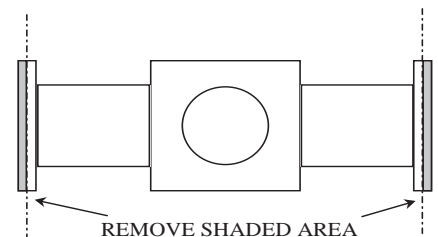

this stage. Leave the bogie to set for at least 1 hour, 2 is better.

With the joints set hard you can now set the axle bearings:

25.6) There is less side-play evident in the DMU bogies than is found in our coach bogies. If care has been taken so far the wheelsets will require only minimal adjustment of the bearings to obtain optimal performance, If adjustment is necessary begin by inserting a thin piece of card between each wheel and the side frame to prevent lateral movement.

NOTE: Do not over-pack the wheelsets as this might cause the sides to spring when you remove the card later resulting in stiff wheel movement.

25.7) Push in the bearings from the outside until the bearings connect with the axle ends.

25.8) When satisfied that the bearings are (just) against the pinpoint ends fill the bearing hole with 2.5mm dia. scrap sprue, or microrod (not supplied) and fix with liquid solvent from the outside and leave to harden. You may be able to affix the bearing in place with a drop of superglue in the axle box end.

25.9) When set, remove spacing card and trim any excess rod flush with axle box face

25.10) Remove the bogie pivot mounting from the casting sprue and remove any flash. Test the bogie pivot bolt is an easy sliding fit in the mounting hole. If tight, open the slightly with a 3.5mm drill to ensure a smooth swivel movement.

25.11) Drop the bogie pivot mounting into its locating holes in the top of the bogie stretcher plate and, using only sufficient glue to attach the plates, fit keeper plates over pivot spindles. Ensure pivot remains free to move until the liquid solvent has evaporated.

You may prefer to use a larger piece of sheet styrene (not supplied) rather than the moulded keeper plates supplied.

25.12) If desired, fit the brake shoes on the inside of the sideframe. They should be positioned just off the wheels with the circle detail on the shoe just visible below the bottom of the side frame.

25.13) Fit the bolster detail centrally to the inside of the sideframe by placing the square beam against the back of the sideframe and butt against the underside of the bogie stretcher - photo: Bogie Sprue Labelled.jpg.

While the basic bogie assembly sets, identify and remove the bogie front channel, guard irons, speedo drive mount and bogie steps from the etched sheet.

25.14) Fold up the bogie channels E27 (plain) & E28 (with slots for guard irons). The slot for the guard irons needs opening up with a razor saw, use the half etch as a guide.

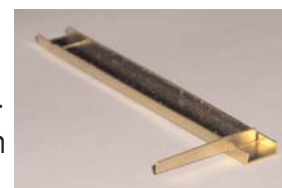

25.15) Locate the guard irons (E26) in the channel with the top of the guard iron firmly against the top of the channel section and passing through the slots and fix in place (these can be glued in place with superglue, or soldered).

25.16) Glue one each of the bogie channels to the front and rear of each bogie with the bottom of the channel level with the bottom of the sideframe end (superglue is recommended for this). The guard irons go to the front of the bogie in each case (the motor is at the rear of the power bogie). See also Bogie end channel in place.

25.17) Glue the speedo drive mounting (E21) to the front left axle box. The spike faces right and down when fitted in place - photo: Bogie speedo drive.jpg.

25.18) Fold up the bogie step tread supports and mounting brackets (E5).

25.19) Glue the bogie step mountings in place. The front mounting is in line with the front spring hanger and the bottom step tread should be (approximately) level with the large spring mounting bobbin. The step mounting legs have a half etch fold line on the back

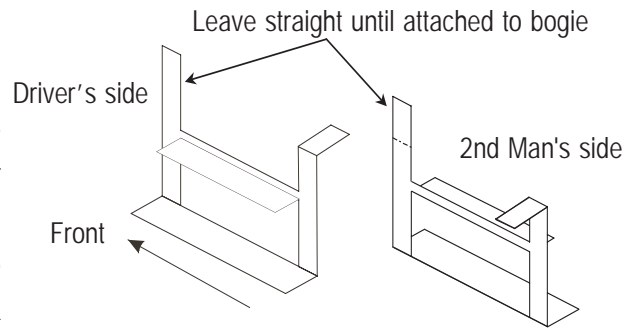

about 2mm from the top. Fold only one of these 90° and make a right and left hand pair - reinforce the fold. The straight leg is bent over to the front bogie channel once the step mounting is in place - reinforce with epoxy resin. Keep the steps parallel to the side frame and attach the rear mounting to the top of the side frame - photo: Bogie step and speedo drive.jpg, but note the front mounting leg has yet to be bent down to meet the bogie frame in the photograph.

***TIP Flattening the front spring hanger 'bobbin' back to the level of the leaf spring greatly simplifies the fitting of the step mountings. Although un-prototypical, once painted the flatness is hardly noticeable.*

Power bogie - general arrangement

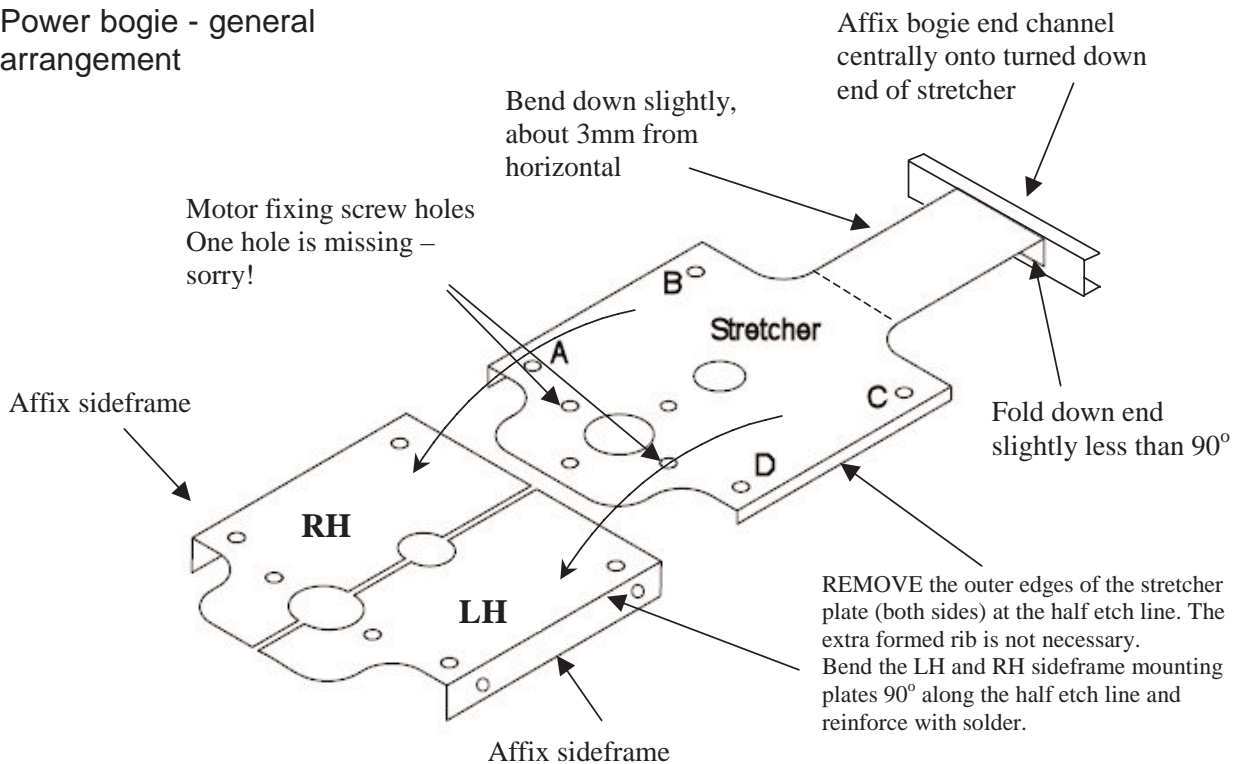

POWER BOGIE

26.1) Find the brass power-bogie stretcher-plate, the two sideframe mountings (LH & RH) and axle bearings. Put the bogie pivot 'top hat' to one side (safe!) until required to actually mount the bogie.

26.2) Fit axle bearings into the two remaining bogie sideframes

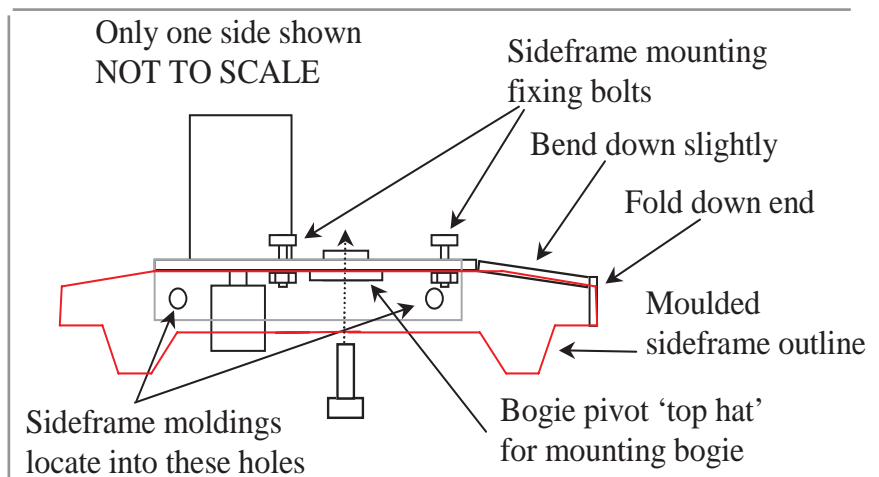

as per the un-powered bogies.

26.3) Push the two moulded pins of each sideframe through the holes in a sideframe mounting (with the folded sides hanging down) and glue into place.

26.4) Fold down the end of the bogie stretcher plate at the half etch and the whole extension about 3mm from the horizontal (this might need further adjustment later on).

26.5) Bolt one sideframe assembly to the bogie stretcher plate with 2x 2mm nuts and bolts provided.

26.6) Insert the wheelsets into the assembly ensuring the set with the brass gearwheel is at the same end as the motor mounting and that the two sprockets are both on the same side.

26.7) Fit the opposite sideframe assembly as before.

26.8) Form the bogie end channel with guard irons (E28 & E26) and afix to the folded down end of the stretcher plate. **DO NOT GLUE TO EITHER SIDEFAME.** As before, the bottom of the channel should be level with the bottom of the sideframe end, you might need to adjust the stretcher-plate extension a little to achieve this.

26.9) Finish off detailing the bogie assembly as outlined for the non-powered bogie, not forgetting the central bolster details, which are superglued to the inside of the sideframe mountings.

26.10) The guard's door have additional steps fitted to the rear of the bogie in a similar manner to those at the front. Two extra step mountings are provided for the purpose. Align the steps with the guard's door. Fold the step mounting as for the main step, but fold over the top of both mounting legs. Follow the same construction methods as for the main bogie-mounted steps noted earlier - photo: Bogie Showing Guard Steps.JPG.

26.11) Fit the motor to the frame stretcher and glue the pick-ups to the stretcher underside ensuring the wipers have a good contact with the backs of the wheels. Trim back the pick-up wires as necessary.

26.12) Align the worm wheel with centerline of the gear and clip the drive chain in place. **DO NOT MAKE THE CHAIN TOO TIGHT AS THIS WILL CAUSE EXCESSIVE GEAR NOISE AND WEAR IN THE COMPONENTS AND THUS PREMATURE FAILURE.**

26.13) Lightly lubricate all moving parts and test.

26.14) There are two different types of axle box covers supplied in the kit, use the slightly domed Timken covers. Fit covers to all remaining axle boxes - photo: Bogie speedo drive.jpg.

26.15) Cut 12 15mm x 5mm x 0.7mm (30 thou) step treads and fix to the step supports as required.

BODY ASSEMBLY CONTINUED...

OK, the sides and ends will now be firmly fixed so will withstand the handling necessary to fit the roof.

27) Fit the two alloy roof retaining 'nuts' in the roof groove and slide to a position directly above that of the 4mm hole in the floor at each end - some filing of the captive nuts will be required to enable easy fitting, but try not to make them a sloppy fit.

28) Test fit the roof between the ends. Assuming everything has been assembled accurately the roof should be a snug fit. If tight, file and sand the end of the roof moulding until a snug fit is achieved. When the roof is in place the top of the sides will locate in the groove under the rainstrip. Fix the roof in place by initially applying solvent from the inside along the joint of the cabs/roof moulding then along the joint between the roof and the side mouldings, again from the inside. Be very generous with the solvent here as the ABS can be reluctant to soften.

29) (Optional) To make a very secure job, reinforce the sides/roof joint with 30thou (0.7mm) micro rod again with liberal amounts of solvent.

30) Insert the floor and clamp the assembly together with the long bolts provided and set aside until the roof has fully hardened.

LEAVE BODY TO HARDEN

31) Once the roof has firmly set, remove the floor. Check for fit and install the thick ABS partition between the two small windows adjacent to the guard/baggage doors. Make sure the divider neither spreads, nor pinches the sides together once fitted as this will affect the fitting of the floor later.

32) Although it makes filling the cab/roof joint harder to do, fitting the large headcode first does improve the final appearance - your choice fit now, or later.

32a) Take time now to inspect the fit of the roof against the end moulding. Due to the different means by which the roof and ends are produced, it will be found that the alignment of the roof and the ends require some blending. Car body filler ideal for this. It is recommended practice to apply filler in a few thin layers rather than a single thick layer, rubbing down each layer as required with wet and dry abrasive papers.

Once again, do take your time with this last step not least because the roof and end joints will always be very visible.

33) If not previously fitted, fit the prepared roof headcodes, or destination display casting to the cab roofs as appropriate. Again some fitting and filling will be required to make a neat job.

34) Fit the roof vents into the previously drilled mounting holes.

UNDERFLOOR ASSEMBLY

NOTE: The moulded ribs on the floor moulding determine the underside of the floor moulding!

35) Check the floors will fit within the sides and end moulding. It is likely that you will have to adjust the floor width to gain the best fit. Do this carefully removing the minimum amount evenly from each side to keep the floor centrally aligned to the body. This is best done using a scraping action with a sharp blade. Don't be tempted to make the floor an 'only just go in' type of fit; remember you will be painting the floor and body so a tight fit could become a not fit later. The floor should simply sit on the moulded ribs of the sides without any force being necessary to put in place.

36) To improve the visual appearance of the underframe, cut the two lengths of 5mm wide 0.5mm styrene to 437mm and affix to the outside face of the moulded solebars (you may find your kit has 4 shorter strips of material from which to produce this feature). Align the strips so that they overhang each end by an equal amount (take care when handling so as not to break the ends). Keep the strip firmly butted against the underside of the floor lip. Reinforce the backs of the the solebar extensions with off-cuts of styrene as appropriate.

37) Remove the two bufferbeams from their sprues together with their associated extension collars, clean flash, etc. and check the fit of the buffer shanks into the holes. Use a 3mm drill bit to carefully open any tight holes to allow the buffers to slide easily. Use a buffer to align the buffer stock extension collar to the end of the buffer housing - affix with solvent and remove the buffer immediately. Once the joints have hardened, carefully run the 3mm drill through again to

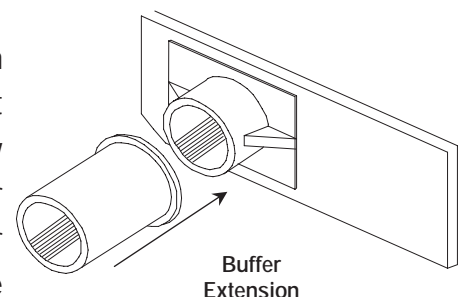

ensure the holes are clean.

38) Install the floor into the body and temporarily secure into position. Now fit the bufferbeams to the underside of the cab ends, aligned centrally across the cab and butted firmly against the ends of the extended solebars to ensure vertical squareness. **DO NOT GLUE THE BUFFERBEAM TO THE SOLEBAR EXTENSIONS AS THIS WILL ALSO PREVENT THE FLOOR FROM BEING REMOVED.**

***TIP - Adding fillets of scrap styrene between the underside of the cab and the bufferbeam will greatly increase the security of the assembly. Aligning the fillets with the underframe ribs will ensure they will not interfere with fitting other details, or the couplings later.*

39) Lamp irons (E16) are fitted to the outer edge of the buffer stocks. First remove the outer two moulded bolt heads from the face of the buffer stock. Bend the lamp iron to form a joggle using the half etched dimples as a guide and glue to the face of the buffer stock, see right. Superglue is recommended for this. Reinforcing the folds first is strongly recommended.

40) Drill two 1.8mm holes in the bufferbeam at the guard end only to accept the exhaust pipes. The holes should be 4mm in from the edge of the buffer mounting pad and hard against the underside of the cab floor (left hand side only shown).

41) Using the supplied 1.8mm nickel silver rod, form the two exhaust stacks that go up the front of the cab at the guard end of the unit. You may prefer to anneal the rod first to ease the forming, however the pipes can be formed without annealing, but the metal is harder to bend. To give you a start in forming the stacks see the diagrams/photos **EXHAUST STACKS** (page 18). The images have a 5mm x 5mm grid as a background, which can be used to scale the positions of the various bends. The flanges can be made from the spare mounting rings (E31) soldered to the rod as shown. Do Not mount until the model is painted. Drill small holes in the cab front in the channels between the outer windows and the centre window to accept the mounting pins on the stacks.

42) Add vac pipes (C3) by mounting the flat bar onto the back of the bufferbeam. The 'hoses' should appear to come through the bufferbeam about 7mm either side of the coupling hook with the stowing bar offset by about another 1.5mm.

43) The stowed MU fittings (C29) require the ends drilling to accept thin wire pegs for the flexible tube 'cables' to attach to later. Gently file each end flat before making a dimple with a sharp object and then drill with a 0.6mm drill bit. Secure the wire pegs with a touch of superglue. Now add the MU sockets C29 and C30 to the underside of the bufferbeam centred below the buffer housings. The closed sockets go on the driver's side of the cab, i.e. the right hand side as you look at the front of the cab (with the body the right way up!)

44) The air horn (C1) should fit behind the bufferbeam on the driver's side, however, it's getting a bit crowded in there and it can also foul the bogie on tighter radius curves. We suggest fitting the horn to the bogie front against the guard iron. If you opt to do this, reduce the length of the mounting bar to just above

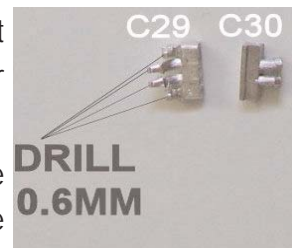
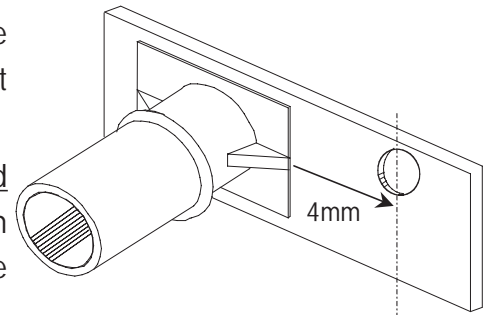
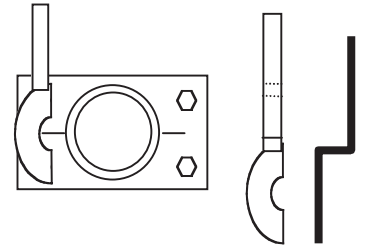

the first horn and butt it up to the bottom of the front channel.

The floor moulding can now be removed from the body and the remaining details fitted to the body and underframe.

ADDING THE REMAINING DETAILS

45) Assemble the control desk details as per the diagram on page 18 and check for fit inside the cab.

46) Back on the outside of the cab you will need to drill 3x 0.7mm dia. holes through the seam between the cab end and the body side moulding. These holes apply only to the driver's door to the left end of the body on both sides because the holes can't be drilled, nor hinges fitted until the ends and sides are assembled. The hinges should be positioned to align with the other hinges (4.5mm, 20mm and 38.5mm as measured from the bottom of the body); fit the hinges in the same manner as before. However, if your model is to have full yellow ends consider leaving them off until after painting as this greatly simplifies masking off the end. Make up the six hinges (4x tall, 2x short) using either superglue, or solder and paint yellow and blue before fitting.

***Note - Door hinges are always on the left of a door as you look at the it.*

47) From scrap styrene cut two cab floors 14mm x 57mm (or whatever your model measures between the moulded ribs at the bottom of the sides - minus about 0.5mm for clearance), fold the base of the drivers etched partitions (E20 & E23) to 90° and fit to the floors. Fit into position trimming as necessary to achieve a snug fit. You may wish to add some scrap styrene to the inner body sides to offer some additional support towards to upper part of the partition (do not obstruct the window openings and remember the glazing will need to be fitted later). Clean and fit the cab seat to this short cab floor positioned to roughly align with the curved recess in the cab desk and its back just clear of the partition - photo: mid body strengthener and cab walls.jpeg.

48) Attach the body stretchers (58mm x 14mm ABS mouldings) to the inside the body above the body side rib and aligned with the 1st and 4th passenger doors (counted from the non-guard end), reinforced as appropriate to give good strong joints. The completed underfloor is then fitted into the body and drilled through both the floor and the new support. Remove the floor and open the holes in the floor to clear the self tapping screws. Now carefully screw the self tapping screw into the stretcher to initially form the thread - photo: Body Stretcher.jpg. The guard end of the underframe is secured using the long 4mm bolt into the roof.

UNDERFRAME DETAILS

***TIP - the underframe details are best tackled by studying the drawings and photographs. However it has been found helpful to construct small sub-assemblies and then attach these to the underfloor. The position of the guard's door is the key to parts positioning. So here goes...*

49.1) Clean the flash from all castings.

49.2) Fit the radiator grilles (E3) onto the front of the radiator castings C26.

49.3) Fit castings C2, C17 and C18 to the diesel engine C22 as shown right.

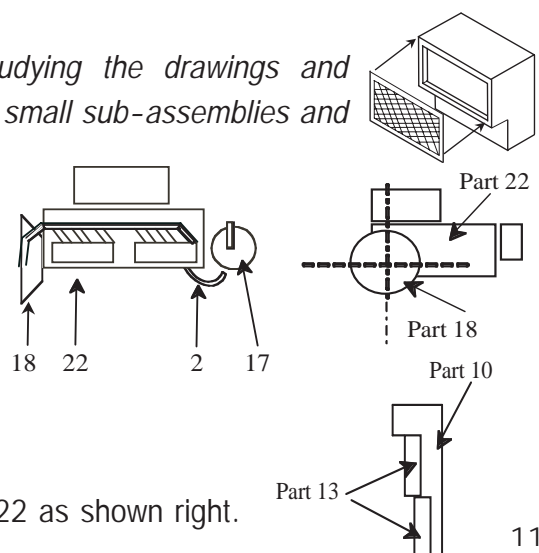

49.4) Fix castings 2 C13s to C10 as shown right.

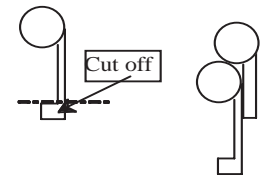

We now need to modify a couple of castings...

49.5) Modify one of the air tanks C21 by cutting off the bottom of its mounting foot. Now piggy-back this air tank onto the other as shown right. You might find you kit has the two air tanks cast as a single item, if so, ignore this line!

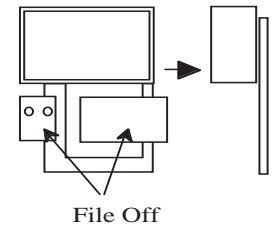

49.6) Cut and file the two small boxes from casting C8 and remove the mounting foot from the rear. This will leave you with (mainly) a single large box with a flat mounting, see right.



49.7) Cut the pipe extensions off the exhaust silencers C9 as shown right.

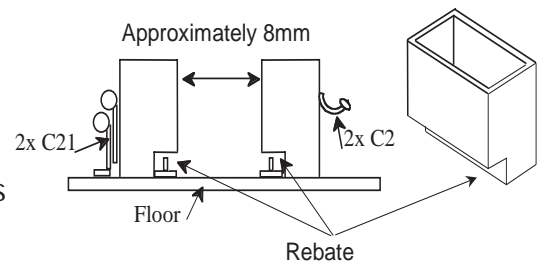

49.8) The fuel tanks require a simple modification as shown in the diagram (right). Cut a rebate in the bottom of the tanks so that they can overhang the moulded ribs on the underside of the floor.

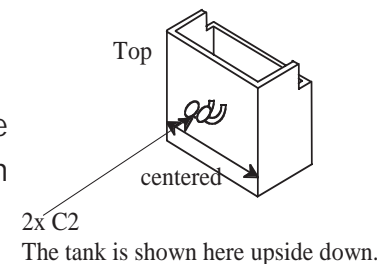

49.9) Add 2 fillers C2 to one tank as shown in the diagram, they should be positioned (vertically) so that the filler caps are just below the solebar. Prototype photo: Exhaust And Radiator.JPG

49.10) Affix the two piggy-backed air tanks (C21) to the other fuel tank, again centred and positioned level with the top of the fuel tank as shown in the two diagrams here.

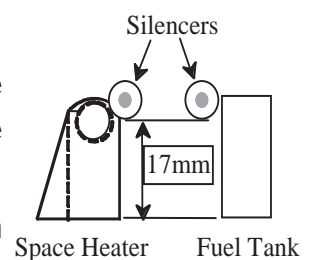

50.1) Having produced the basic sub-assemblies and necessary modifications, score the underside of the floor moulding in the appropriate positions and affix the parts in place using the underfloor diagrams as a guide (pages 15 & 16). Have a dry-run first and simply position the main components in place taking care to consider bogie movement, which can get very close to some details when on tight radii curves. It may seem obvious, but some castings will need to stand in front of others, so ensure the outermost casting will still fit behind the solebar with the rear casting(s) in place prior to applying glue. The easiest mistake to make is to mis-read the diagram; remember the floor is upside down and what is to your left during construction will be to the right when the underframe is completed. A 'NOT 12

TO SCALE' diagram of the underside as you look at it during construction is provided for extra clarity.

50.2) When fitting the fuel tanks notice that there should be a gap between them of about 8mm. It is important to ensure there is a sufficient space here to enable you to fit a body mounting screw later on.

51.1) With the basics of the underframe in place let's look at the exhaust systems. It is probably easiest to create these by reference to the numerous photos on the CDROM, both of the prototype and our demo model. Each system is made up of three components: pipe, silencer and pipe. Locating the modified silencers first is a good starting point then create the pipe from the manifold stub on the diesel engine followed by the pipe that disappears into the underfloor.

51.2) So, fix a silencer to the rear of one of the space heaters and the other to the front of a fuel tank, using the diagram opposite as a guide. The silencers are centred in length on the fuel tank and space heater.

51.3) First consult the diagrams on pages 15 & 16 to get an idea of the pipe runs. Use the remaining 1.8mm nickel silver rod to make the pipe runs to and from the silencers - annealing will certainly be beneficial here. To fix the pipes to the engine manifold stub and the silencers, first tin the ends of the rod with 145deg solder and then use a low wattage iron to attach to the cast pewter parts with 70deg solder. If soldering isn't for you, thoroughly clean the parts and use superglue to tack the items together; reinforce the joints with epoxy resin as necessary. If done with care and reinforced away from the main line of sight a very satisfactory job can be achieved without using solder.

52) Locate the remaining speedo drive parts (etched part E25 and small 'square' castings from C5). Fit the speedo drive backing etched part to the sole bar 45mm from end of floor moulding with spike pointing down with the smaller speedo casting glued in place on top.

NOTE: If the floor is upside down, the speedo details are fitted to the righthand end of the solebar closest to you, i.e. the one you can see the outer face of, that's the driver's side.

53) Cut 2 off 30mm x 5mm, 16 off 20mm x 5mm and 8 off 15mm x 5mm pieces of 0.7mm (30 thou) styrene as step treads. You will require 4 more if you have fitted the additional steps for the guard's doors onto the bogie, cut to length as necessary.

***TIP - In each case the outer edges should not be left too square cut, i.e. round off the upper edges and slightly round the corners. The steps were wooden and soon became worn.*

54) Afix the 20mm step treads centrally to the solebars and aligned with the various doors as required and the 30mm steps aligned with the baggage/guard's doors. Extra strength can be gained by adding micro rod (not supplied) to the underside of the step/solebar joint should you wish. The 15mm long step treads are for the bogie steps and are afixed to the tops of the folded step tread supports.

That just about covers the basics of the underframe details. Of course there is a great deal more under there, but you've got a good starting point for a more detailed model, or sufficient for most situations. If you really 'go to town' with the underframe detailing please do share your work with us and we will display you handiwork on our web site.

INTERIOR

55) Cut two sub-floors to mount the seating on. You will need one floor 20mm x 310mm and one 30mm x 310mm. Start with the body upside down and the non-guard end cab partition in place. Insert each floor in turn butted up against the cab partition, now mark all the door positions on the floor (mark

the width of the actual door opening). If you have reinforced the body stretchers on the underside, you may need to make small cut-outs where appropriate to enable the floors to sit firmly against the sides.

56.1) Remove the appropriate number of seats (13 of each type) from the sprues and prepare them by removing the ejection pin marks (small round marks on seat back) and moulding feed joints.

56.2) To form the seat, flex the moulding until the joint between the base and seat back shows a thin white line. Apply solvent, or superglue to the joint holding together briefly to prevent the back from initially springing apart.

57) Bend the bottom mounting plates of the central partition (E24) 90° and check for fit between the sides.

58) Once the floors and seats have been painted, transfer the door opening marks to the upper surfaces and affix the seats in pairs (back-to-back) making sure they clear the door openings and any body stretchers according to the floor plan diagram. Do not fit the four seats either side of the central saloon partition. This partition is situated between the two adjacent small windows in the passenger compartment - see **SEATING FLOOR PLAN** page 18.

59) Bend the blade part of the windscreen wipers (E24) 90 degrees to the arms so that they present a blade edge to the windscreen ensuring you create two left and two right handed wipers. Solder/glue a piece of 0.4mm wire through the mounting holes in the arms, paint silver, or black.

FINISHING

60) With the main construction now completed it is time to prepare the model for painting. Whilst this consists of mainly cleaning and washing of all the parts, it also gives you another opportunity to check the security of the various fittings. Anything that cannot stand cleaning now will probably not withstand long-term use, so it's better to have bits falling off now than later! Re-affix as required. When painting, don't forget the interior details including the window grilles E6 which should be painted grey, or white)

Painting is not a subject to be condensed into a few lines, so we will assume that you already have the means to produce the required livery (if not we can help). We recommend the excellent transfers supplied by Fox Transfers. Phoenix Precision Paints and Rail Match have both been used on our kits and give excellent results Phoenix Precision primer has good adhesive properties on this type of plastic.

FINAL ASSEMBLY

61) Starting inside the body, find the windscreens you put in a safe place some time ago and fit using small amounts of dilute canopy glue, such as RC Modellers glue. Dilute to consistency of milk and add a drop of detergent then apply from the inside with a small brush to the edge of the glazing allowing capillary action to draw the liquid into the joint. Wash brush immediately afterwards to remove traces of glue.

62) The main side windows should be pressed into the openings from inside. Start by checking each pane will go into the opening without forcing, or distortion. If too tight, carefully fettle the edges of the pane until a comfortable fit is achieved, check for being parallel to body and then apply canopy glue as before.

63) Fit the control desks on to the desk supports with two part epoxy.

64) Fit the centre divider between the two small windows in the passenger compartment

(between the 5th and 6th doors counted from the non-guard end) ensuring the bottom of the divider is level with the top of the false floors (or level with the top of the moulded side rib). Remember to orientate the divider correctly as the door is off-centre to align with the double and triple seats.

65) With the centre divider securely in place, fix the 4 seats not affixed to the false floors directly to the divider and body side (you will need some scraps of styrene to provide extra support and gluing surfaces).

66) Fit the cab partitions in place, installing crew members first if required, with the bottom of the cab floor level with the bottom of the moulded side ribs. Fix in place with small amounts of epoxy resin.

67) Affix the two window grilles behind the first window of the baggage compartment (immediately behind the cab partition). Bending the top 2mm of the grill slightly will allow it to sit level with the window pane. Ensure the grille is aligned with the window opening.

68) Insert the two false floors and secure in place with adhesive tape to the bottom of the cab floor and to the plastic baggage compartment divider - this just helps to prevent the floors moving sideways before the underframe is fixed in place.

69) Insert the underframe and secure in place.

70) Fix the previously formed exhaust stacks to the guard's end of the unit.

71) Check the fit of the buffers in the stocks once again for a sliding fit, adjust as necessary and fit the buffers into the stocks. To spring the buffers create a loop of the spring wire (supplied), pass each end of the loop through the hole in the buffer shank. Secure the spring in place by passing the coupling shank through the hole in the loop and trap with the coupling mounting washer, spring and split pin, see right.

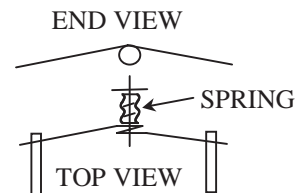

72.1) Mount the bogies using the 4mm bolts provided and ensure they are free to rotate. The power bogie is mounted using the bogie pivot 'top-hat' inserted into the bogie stretcher plate from the underside. This bolt should be tightened fully against the top hat allowing the bogie to pivot around the top hat. The pivot bolt for the non-powered bogie should **not** be fully tightened, or the bogie will not swivel, so secure the pivot screw with a little adhesive (PVA, or canopy glue) to prevent it from unscrewing, but don't over do it.

72.2) The speedo drive cables are created from thin silicon tubing. Do not make the link too short as it will restrict bogie movement, however if too long it may snag on trackside components. Start with about 35mm and work back from there until it looks right, but still gives sufficient bogie movement.

73) Fix the preformed windscreen wipers into the holes previously drilled above the upper edges of the windscreen beading. The wipers are intended to be in the parked positions, which is up against the outer edges of the windscreens - photo: Craven end 2.jpg for example.

74) Fit all door 'T-handles', grab handles (E17) and cab door handrails (E1). Also, fit the handrails to the guard's doors. It should also be noted the guard's door has a special etched door handle (E13) and the baggage door handles are part E14.

75) Add the MU 'cables' to the pegs using silicon tubing. Each cable should be approx. 20mm long.

We hope you have enjoyed building this kit and welcome your comments.

“EASY-BUILD”

Trenarth, Victoria Road, Camelford, Cornwall, PL32 9XE.

Tel: 07834 063966 (before 9pm please)

e-mail: shawn_easybuild@btinternet.com

web: www.easybuildcoaches.co.uk

Notes on using etched cab front window frames.

You will find a set of etched window frames on the small sheet of etched details. These can be used as replacements to the moulded cab window frames. They are slightly shorter in height so some care needs to be excersied when fitting. Basically, carefully file the moulded window frames flush with the cab front surface and finish with fine abrasive paper. Looking at the rear of the etched frames you will notice the etched rebate is wider at one end - THIS END IS THE BOTTOM. Use superglue to fix the frames into the openings using the bottom rebate to align the frames. The top of the etched frame just reaches the top of the opening, but does not overlap onto it. It sounds a bit hit and miss, but it does work!

UNDERFLOOR DETAILS LAYOUT

(Details viewed as they appear when vehicle is on its wheels)

All measurements taken from the guard end of the floor excluding the solebar extensions

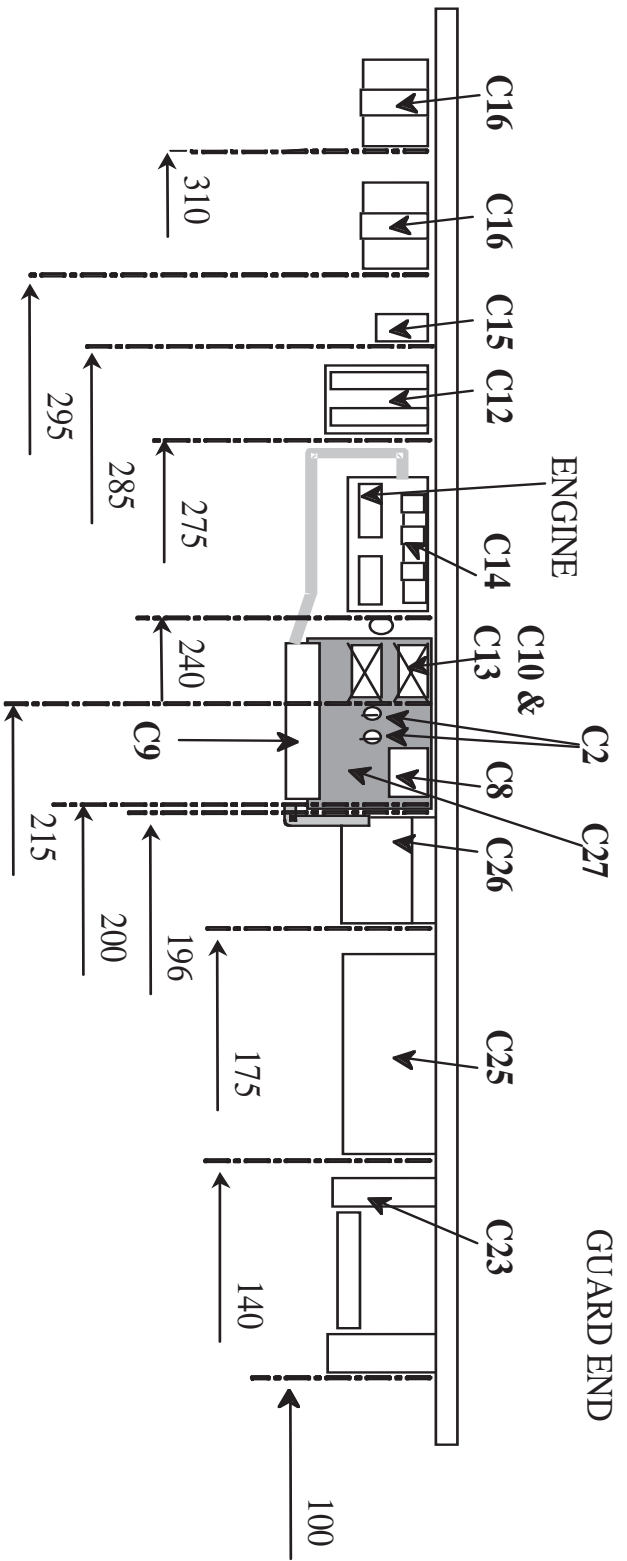

All measurements taken from the guard end of the floor excluding the solebar extensions

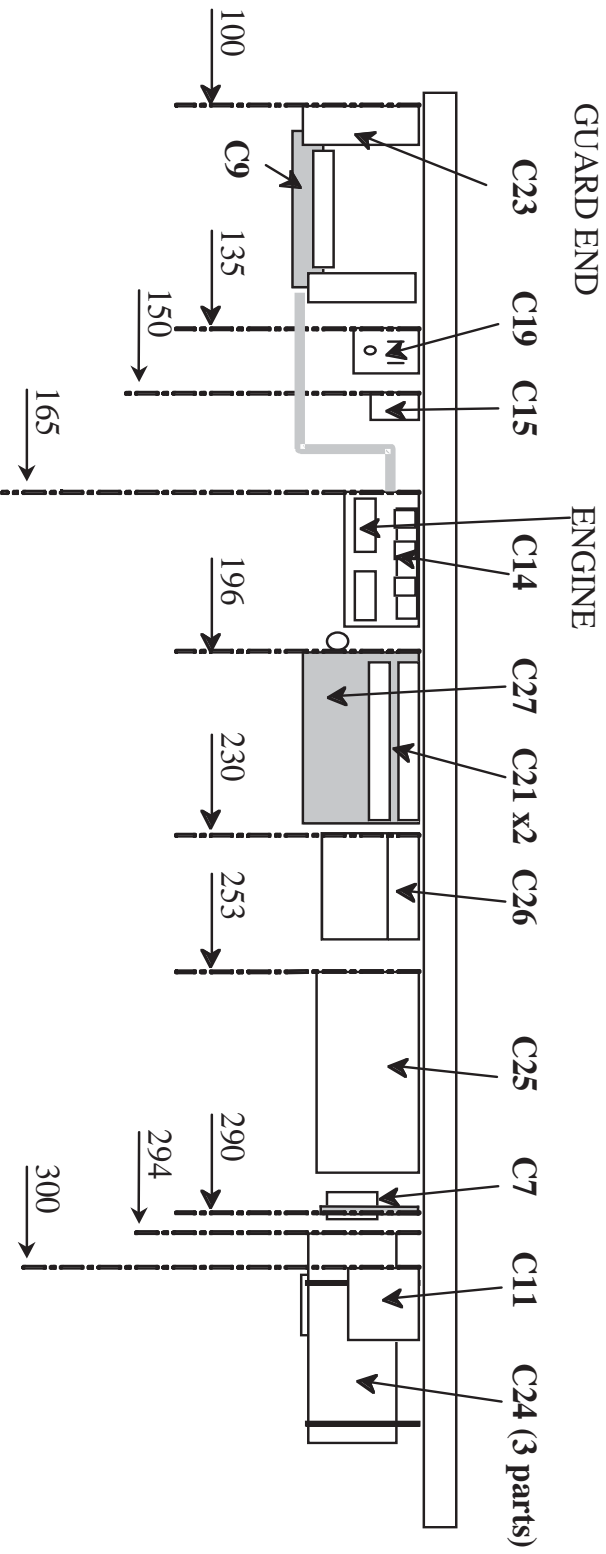

MODIFICATION TO FLOOR

Since the floor of the power car was designed we've had to obtain our gearsets from a different supplier. This change meant we had to alter the position of the motor, which in turn created a problem with the aluminium bogie mounting. If fitted as described the motor will foul the edge of the round bogie mounting. So, with the round aluminium mounting is securely in place as described in the main text, file, or cut off the edge of the floor motor opening and mounting sufficiently to allow the motor to move through its full range. See diagram below.

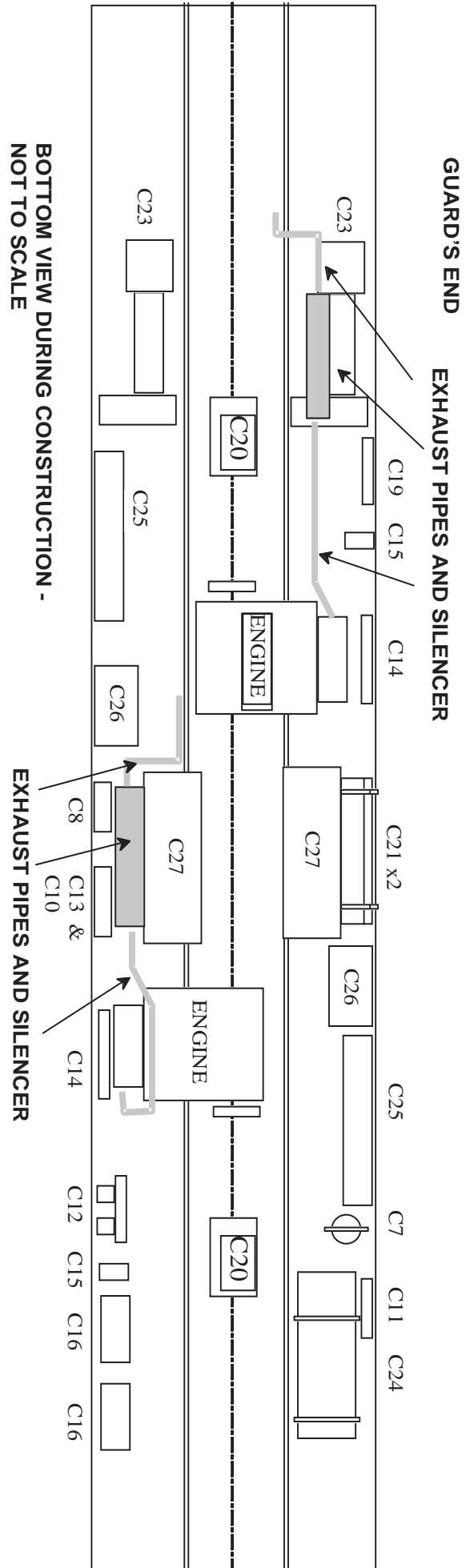
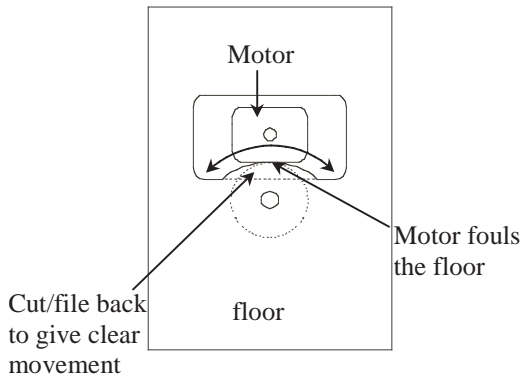

CASTINGS

NOTE: the actual arrangement of castings may vary.

- C1: AIR HORNS**
- C2: FILLER CAPS**
- C3: VAC PIPES**
- C4: CONTROL DESK DETAILS**
- C5: SPEEDO DETAILS**
- C6: CONTROL DESKS**
- C7: FILTER ASSEMBLY**
- C8: ELECTRICAL BOX ASSEMBLY.**
- C9: EXHAUST SILENCER**
- C10: ELECTRICAL BOX MOUNTINGS**
- C11: LIGHTING CONTROL BOX**
- C12: RELAY BOX**
- C13: ELECTRICAL BOX**
- C14: SWITCHES ASSEMBLY**
- C15: BUTTON BOX**
- C16: RELAY BOX**
- C17: ENGINE FILTER**
- C18: ENGINE FLYWHEEL**
- C19: BATTERY ISOLATOR BOX**
- C20: GEARBOX**
- C21: AIR TANK**
- C22: ENGINE**
- C23: SPACE HEATER**
- C24: VAC TANK**
- C25: BATTERY BOX**
- C26: RADIATOR**
- C27: FUEL TANK**
- C28: SMALL DESTINATION BOX**
- C29: MU STOWED PLUGS AND SOCKETS**
- C30: MU CLOSED SOCKETS**
- C31: DRIVER SEATS**

Also included in casting pack are 16 turned brass door T handles.

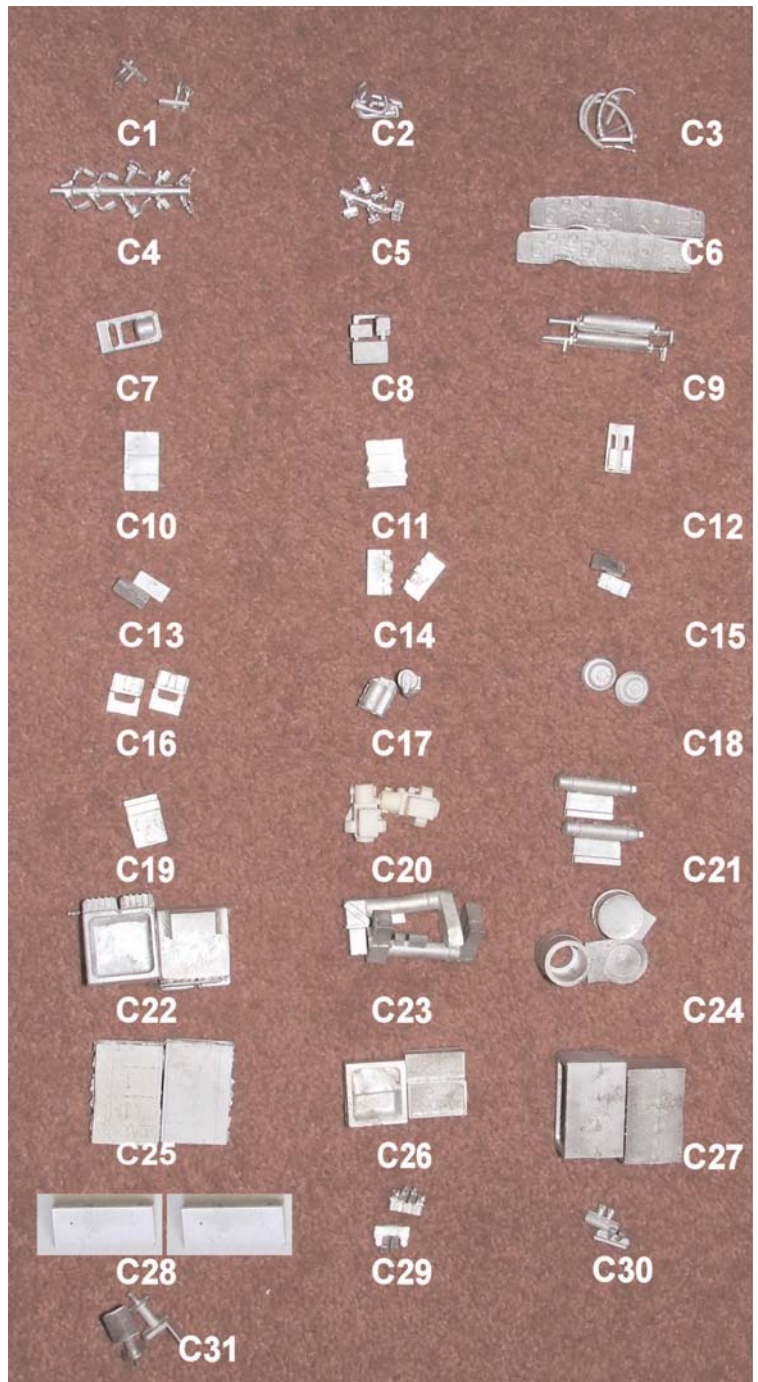

KEY TO ETCHED SHEET OF DETAIL PARTS (SMALL)

- E11: ROOF HEADCODE BOX**
- E12: HEADCODE BOX FRONT**
- E15: 2-DIGIT HEADCODE FRAME**
- E29: HEADCODE BOX FRONT BACKING PLATE**
- E30: REPLACEMENT CAB WINDOW FRAMES**
- E31: EXHAUST STACK MOUNTING RINGS**

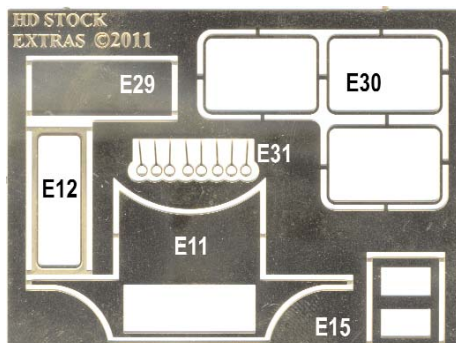

EXHAUST STACKS CLASS 121

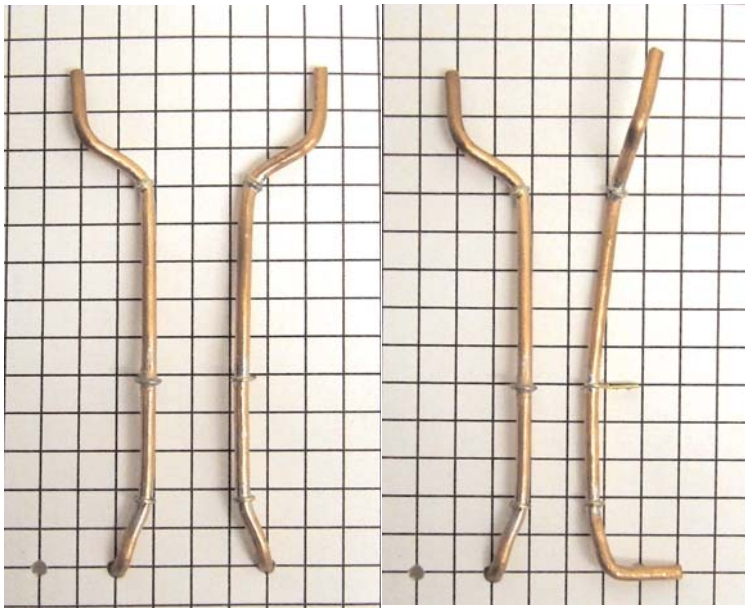

EXHAUST STACKS CLASS 122

The 122 stacks do not have the top bends as shown here (left), but simply go straight up either side of the small destination box.

Above the gutter they curve gently back and then turn back vertical as shown right (not to scale). Originally the exhausts turned inwards above the destination box and joined in a central collector box. This box scales to approx.

7mm x 7mm x 3mm. The overall height of the stacks is the same as the 121 stacks in the illustrations (left).

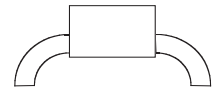
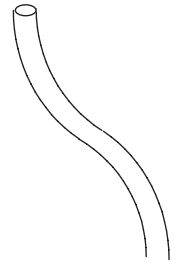

CONTROL DESK DETAILS

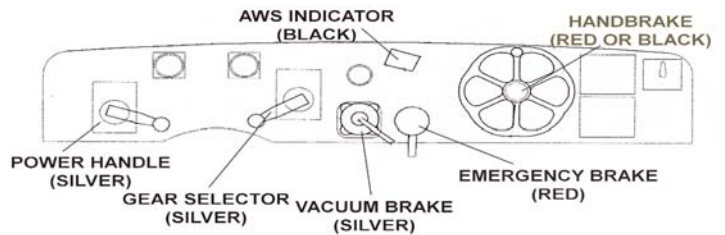

ROOF VENTS

All measurements (in mm) taken from passenger compartment end of roof **before fitting**

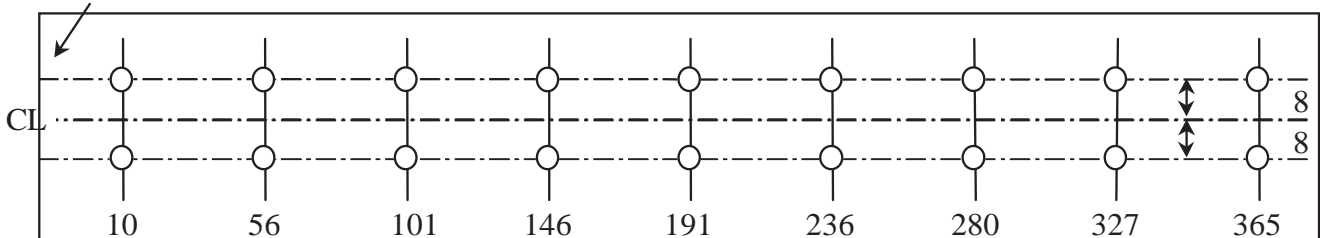

SEATING FLOOR PLAN

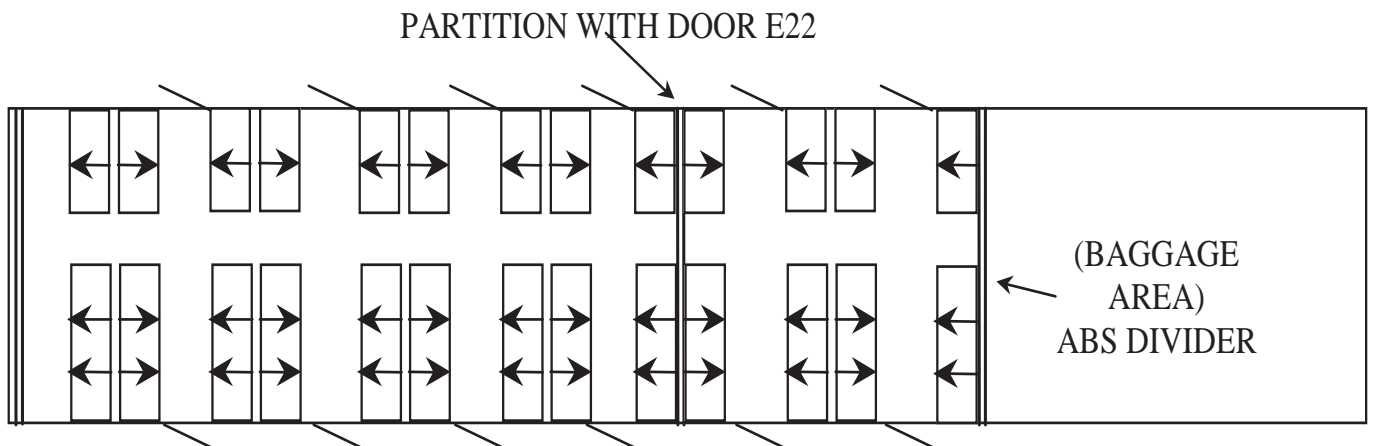

KEY TO ETCHED SHEET OF DETAIL PARTS (LARGE)

- E1: CAB HANDRAILS
- E2: BRAKE HANGERS
- E3: RADIATOR GRILLS
- E4: CONTROL DESK BRAKE WHEELS
- E5: BOGIE STEPS
- E6: BAGGAGE COMPARTMENT WINDOW MESH
- E7: BRAKE LEVERS
- E8: FALSE FLOOR SUPPORT BRACKETS
- E9: INTERIOR DESTINATION BOARD FRONT
- E10: INTERIOR DESTINATION BOARD REAR
- E11: ROOF HEADCODE BOX
- E12: HEADCODE BOX FRONT
- E13: GUARD'S DOOR HANDLE
- E14: BAGGAGE DOOR HANDLE
- E15: 2-DIGIT HEADCODE FRAME
- E16: LAMP IRONS
- E17: GRAB HANDLES
- E18: DOOR HINGES (TALL AND SHORT)
- E19: DOOR HINGE BUTTERFLIES
- E20: CAB WALL (BAGGAGE END)
- E21: SPEEDO BACKING (BOGIE MOUNT)
- E22: SALOON DIVIDER (OFFSET DOOR)
- E23: CAB DIVIDER (PASSENGER END)
- E24: WINDSCREEN WIPERS
- E25: SPEEDO BACKING (CHASSIS MOUNT)
- E26: BOGIE GUARD IRONS
- E27: PLAIN BOGIE CHANNEL
- E28: GUARD IRON BOGIE CHANNEL

